

USER GUIDE

Electronic Bidet Seat



VICLEAN[®]

BEYOND TECHNOLOGY

Powered by TOTO

Functions

Functions			VICLEAN [®]
Basic Functions	Cleanse	Rearwash	●
		Rear soft cleanse	
		Ladywash	
	Changing the washing method	Nozzle position adjustment	●
		Water volume	
		Oscillating comfort wash	
		Pulsating wash	
		User setting	
	Drying	Air dryer	●
	Changing the temperature	Temperature adjustment	●
Sanitary Functions	Removing odors	Air purifier	●
Convenient Functions	Opening and closing	Remote controlled seat and lid	●
		Automatic open / close (seat and lid)	
	Lighting up	Night light	
	Heating the toilet seat	Heated seat	●
	Energy saving	Timer energy saver	●
		Auto energy saver	●
Maintenance		Removable toilet lid	●
		Nozzle cleaning	●

Table of Contents

Introduction

Operation

Maintenance

Reference

Safety Precautions	4
Operational Precautions	10
Parts Names	12
Preparation	14

Basic Operations	16
Automatic Functions	20

Air purifier, auto open/close, night light	20
---	----

Temperature adjustment	22
Energy Saver Features	24

Power Plug / Main unit	28
Gap between the Main Unit and the Toilet Lid	30
Deodorizing Filter	31
Nozzle cleaning	32
Water filter drain valve	33

Changing Settings	34
What to Do?.....	46
• If you cannot operate with the remote control	46
• Freeze Damage Prevention ...	47
• Long Periods of Disuse	48
Troubleshooting	59
Important User Guidance Information.....	54
Specifications	55

Model name
Part No.

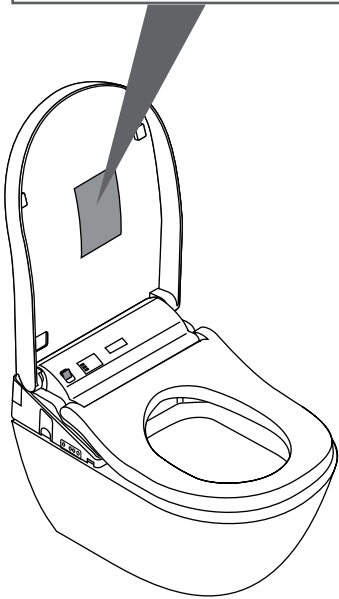

Safety Precautions

These precautions are important for safe usage. Be sure to follow them and use the product correctly.

Symbols and Meanings



WARNING May result in death or serious injury.



CAUTION May result in injury or property damage.

The following symbols are used to indicate important safety instructions for the use of the product.



This symbol indicates a prohibited use of the product.



This symbol is used to indicate a required step in the use of this product.

- This product is classified as Class 1 Equipment and must be grounded.
- The power cord is 0.70 m in length. The electrical outlet should be located on the wall, within the reach of the power plug. Please see the recommendation in the installation guide.
- This appliance is not intended for use by persons (including children) with reduced physical, sensory or mental capabilities, or lack of experience and knowledge, unless they have been given supervision or instruction concerning use of the appliance by a person responsible for their safety. Children should be supervised to ensure that they do not play with the appliance.
- Use the new hose set included with this equipment. Do not reuse an old hose set.



WARNING

Do not touch the power plug or connection of electrical box with wet hands.

- Doing so may cause electrical shock.
Do not get any water or cleaning solution on the main unit or power plug or electrical box.
- Doing so may cause fire, electrical shock, heat or short circuit.
- Doing so may cause the product to crack resulting in injury or water damage.



Never disassemble, repair or alter.

- Doing so may cause fire, electrical shock, heat, short circuit or permanent damage.

Do not install the product on moving vehicles such as wheeled vehicles or boats.

- Doing so may cause fire, electric shock, short circuit or malfunction.
- The toilet seat, toilet lid, main unit or other parts may come loose and fall off, resulting in injury.

Safety Precautions



WARNING

Do not use VICLEAN[®] if a malfunction occurs.

- Always unplug the plug from the outlet.
Always switch the breaker on the distribution board to OFF. (UK)
- Close the water shutoff valve to stop water supply.
Possible malfunctions:
 - Water is leaking from a pipe or the main unit.
 - The product is cracked or broken.
 - The product makes a strange noise or emits a strange odor.
 - The product emits smoke.
 - The product is abnormally hot.
 - The toilet seat cushion is out of place.
- Continued use after malfunction could cause a fire, electric shock, heat, short circuit, injury or water damage.

Only use tap water or potable well water (underground water).

Do not use seawater, industrial water or rainwater for the water supply.

- Doing so may cause irritation to the skin and malfunction.

Do not touch the power plug or electrical box during thunderstorms.

- Doing so may cause electrical shock.



Do not allow the water supply hose to touch the power plug or outlet or electrical box.

- Doing so may cause condensation resulting in a fire, electrical shock, heat or a short.

Do not do anything that may damage the power cord, power plug.

Do not strike, yank, twist, excessively bend, damage, alter, or heat the electrical cords. Also, do not place anything heavy on, bind or pinch the electrical cords.

- Using a damaged electrical cord may result in a fire, electrical shock, heat or short.

Do not use a loose or faulty electrical outlet. (Europe and Russia)

- Doing so may cause fire or short circuit.

Do not use any outlet or wiring equipment beyond its specified rating.
(Europe and Russia)

- Plugging too many plugs into the same outlet, for example using outlet splitters, can cause fire due to heat.

Do not use any power supply other than the one specified.

AC 220V - 240V, 50Hz

- Doing so may cause fire or excessive heat.

Make sure not to splash water, detergents, or urine to the power supply.

- Doing so may cause an electrical shock.

Safety Precautions



WARNING

To reduce the danger of burns, death from electric shock, fire or other human injury:

- Never operate this product if it has a damaged cord or plug, if it is not working properly, if it has been dropped or damaged, or if it has been dropped in water. Return the product to Villeroy & Boch Europe GmbH for examination and repair.
- Never block the air openings of the product or place it on a soft surface, such as a bed or a couch, where the air openings could be blocked. Keep the air openings free of lint, hair or a similar material.
- Never use it while sleepy or drowsy.
- Never drop or insert anything into any opening or hose.
- Do not use it outdoors where aerosol (spray) products are being used or where oxygen is being administered.



Do not bend or distort the nozzle.

- Doing so may cause product damage and performance reduction.

Do not place anything on the warm air outlet or drape clothes over it.

- Doing so may cause burns, electrical shock or malfunction.

Keep cigarettes and other open flames away from the product.

Do not place a heater near the product.

- Failure to do so may cause fire.

Beware of irritation or burn

- Improper use of the toilet seat may cause irritation or burn.
When sitting for a long time on the toilet seat, switch the toilet seat temperature adjustment to „OFF“.
When any of the following persons use a heated seat or warm air drying, someone should switch the toilet seat temperature adjustment to „OFF“ and switch the drying air temperature to „Low“.
 - Young children, the aged and other users unable to set the temperature appropriately themselves
 - The ill, physically disabled and others who do not have freedom of movement.
 - Those using any medicines that cause drowsiness (sleeping or cold medicine), those who have been drinking heavily, anyone severely fatigued and anyone else liable to fall asleep.



To reduce the danger of burns, death from electric shock, fire or other human injury:

- Close supervision is necessary when this product is used by or near children or invalids.
- Use this product only for its intended use as described in this manual. Do not use accessories not recommended by the manufacturer.
- Keep the cord away from heated surfaces.
- Connect this product to a properly grounded outlet only.
- The tank should only be filled with water.

Safety Precautions



WARNING

This is an electrical product. Do not install it anywhere water is likely to get on the product or anywhere with humidity high enough that water is likely to form on the surface of this product. When using the product in a bathroom, install a fan or ventilation port and ensure good air flow through the bathroom.

- Failure to do so may cause fire or electrical shock.

Always connect VICLEAN[®] to the cold water supply.

- Connecting to hot water supply may result in burns and equipment damage.

Electrical power supply should be build by qualified electrical personnel.

Check that an appropriate ground is installed.

- If the ground is not installed, if there is a breakdown or electrical current leak, the lack of a ground could cause electrical shock.
For the ground, use copper wire with a ground resistance of 100 Ω max. and a diameter of 1.6 mm min.
* If there is no ground installed, ask the contractor who did the installation to install the ground.



Make sure that a properly grounded (3 prong) outlet has been installed.

- Failure to install a grounded outlet could cause electrical shock in the event of a malfunction or short circuit.

Check that the outlet for electrical power is as follows.

- Failure to do so may cause fire or electrical shock.
 - a. Apply a current to the outlet (or device) through a differential residual current device (DDR) whose release current does not exceed 30 mA.
 - b. Install the outlet (or device) and its wiring plug at least 0.60 m away from the outside of the shower tub or bathtub.
* Check that the wiring in a. and b. above is complete. If the wiring has not been completed, ask the contractor who did the installation to do it.

Insert the power plug securely into the outlet.

Check that the power cord is connected. (UK)

- Failure to do so may cause fire, heat or short circuit.
* When installing this product, observe the local laws and regulations regarding installation.

To unplug, hold the plug, not the cord. (Europe and Russia)

- Do not unplug by pulling the cord.
- Pulling on the cord may cause damage and result in fire or heat.

Do not use wet hands to insert or remove power plug.

- Doing so may cause a fire or an electrical shock.

If the electric cord is damaged, avoid danger by having the manufacturer's repair department or equivalent specialist replace it.

Safety Precautions



WARNING

Always disconnect the power plug from the outlet before cleaning, maintenance or inspection.

Always switch the breaker on the distribution board to OFF. (UK)



- Failure to do so may cause electrical shock or malfunction.
- * Except when using „Nozzle cleaning“



CAUTION

Do not use the product if the main unit is unstable.

- Doing so may cause the main unit to come loose and fall, resulting in injury.
- If there is backflash in the main unit, consult the installer, seller or the contact listed on the back cover of this manual.

If the product is damaged, do not touch the damaged section.

- Doing so may cause electrical shock or injury.
Replace it immediately.

Do not apply strong force, mechanical shock, step on or stand on the toilet seat, toilet lid or main unit. Also do not place any heavy object on the toilet seat, toilet lid or main unit.



- Doing so may cause cracking or cause the main unit to come loose and fall, resulting in injury.
- Doing so may damage the product and cause injury or water damage.

Do not lift up this product by the toilet seat or lid.

Do not raise the toilet seat or lid while objects are resting on top of the toilet.

- Doing so may cause the main unit to come loose and fall, resulting in injury.

To reduce the danger of death from electric shock:

- Do not use while bathing.
- Do not place or store the product where it could fall or be pulled into a tub or sink.
- Do not put in or drop into water or other liquid.
- Do not try to recover the product if it has fallen into water. Unplug it immediately. Switch the breaker on the distribution board to OFF. (UK)

To prevent a sudden water leak, do not remove the water filter drain valve when the shutoff valve is open.

- Doing so will cause water to spurt out.
(Refer to Page 35 for instructions on cleaning the water filter drain valve.)

Do not fold or crush the water supply hose; do not damage by cutting with a sharp object.

- Doing so may cause water leaks.

Safety Precautions



CAUTION

If a water leak should occur, always close the shutoff valve.

When the ambient temperature is likely to drop to 0°C or lower, prevent damage to the pipes and hoses due to freezing.

- Frozen water pipes could cause the main unit and the pipes to break, resulting in a water leak.
- Regulate the room temperature to prevent the pipes and hoses from freezing during cold months.
- Drain the water



When not using VICLEAN[®] over an extended period of time, drain the water out of the main unit and the water supply hose after closing the water shutoff valve, and pull the electrical plug from the outlet.

Switch the breaker on the distribution board to OFF. (UK)

- When using the product again, allow the product to refill with water first. Otherwise, the water in the tank might become contaminated and cause skin inflammation or other problems. (Refer to Page 50 for instructions on replenishing the water.)
- Leaving the power on may cause fire or heat.

When installing the water filter drain valve, make sure that it is securely tightened in its proper position.

- Failure to securely tighten it may cause a water leaks.

Operational Precautions

For prevention of malfunctions

- Do not block the body sensor or the remote control transmitter or receiver.

About the body sensors

Two types of body sensors are used.

Body sensor A detects changes in heat.

- Detection may be difficult when the room temperature exceeds 30°C, such as in the summertime.
- When sunlight is directly on the sensor area or a heater is used in the bathroom, the sensor may detect incorrectly due to the heat, resulting in the automatic operation of functions such as auto lid opening and closing.
- When the bathroom door is open, the sensor may detect people who pass to the front or side of the toilet.

Body sensor B detects when someone stands in front of the toilet bowl.

- Body sensor B emits an infrared beam as shown in the figure. When someone moves into the line of this infrared beam, the sensor detects the person.

*Detection by the sensor may be difficult when the toilet is used by someone small, such as a child.

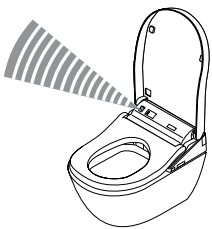

Body sensor A



Body sensor B

About the seat switch

- When you sit on the toilet seat, the seat switch turns ON, enabling you to use various features. (A click sound is heard when the seat switch is ACTIVATED).

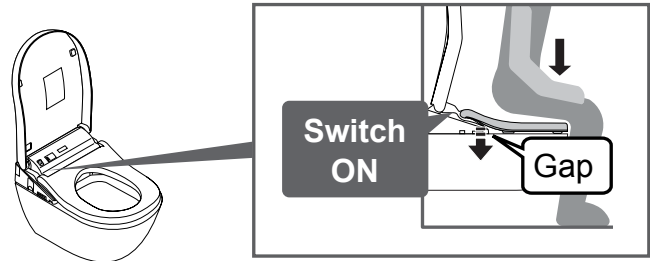

Sit back on the toilet seat.

- The seat switch will not turn on unless you sit on the seat properly.



NOTE

- When a child uses VICLEAN[®], the seat switch may not be ACTIVATED by their light body weight.
- Since the toilet seat is designed to move up and down, a clearance is provided between the toilet seat cushion and the toilet bowl.

For prevention of damage

- Do not lean against the toilet lid.

Problem Prevention

- Disconnect the power plug if there is a risk of lightning. Switch the breaker on the distribution board to OFF. (UK)
- A toilet seat cover or a toilet lid cover can not be used. (The body sensors or seat switch may not function properly.)

Do not put any covers here.

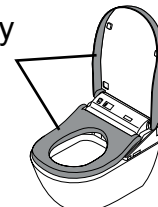

Operational Precautions

- Do not urinate on the main unit, toilet seat or nozzle.
(Doing so may cause pink or brown stains or a malfunction.)
- Do not apply strong forces to the control panel of the remote control.
- Do not expose to direct sunlight.
(Doing so may cause changes in color, irregular heated seat temperature, remote control malfunction or VICLEAN[®] malfunction due to the change in temperature.)
- Use radios, etc. away from VICLEAN[®].
(VICLEAN[®] could cause interference with the radio signal.)
- If you use a booster seat for infants or a soft high chair, remove it after use.
(Keeping it installed may prevent some of the functions from being used.)
- Do not apply force to the remote control.
(May cause malfunction.)
To prevent the remote control from being dropped, set it in the hanger when you are not using it. Be careful not to expose it to water.

About rearwash, rear soft cleanse and ladywash

- These functions wash away waste and dirt from a localized area of your body.
- Do not cleanse too much or for too long.
Doing so may wash away normal bacteria, upsetting the balance of bacteria inside your body.
- People who are receiving medical treatment or therapy in this localized area should consult their doctor before use.

Cleaning instructions

This electronic bidet seat has been designed and manufactured with great care and attention to detail. If you follow a few simple cleaning instructions you will be able to enjoy its comfort, quality and beauty every day.

- In order to ensure the best possible hygiene the surface of the electronic bidet seat is closed and pore-free. Do not use abrasive, corrosive or chlorine based cleaners such as toilet cleaner, household cleaner, benzene, paint thinner, powdered cleanser or nylon scrubbing. These may damage or crack the plastic, lead to discoloration or malfunction. Only use mild ph neutral soap for cleaning.
- Wipe plastic areas such as the main unit and remote control with a soft cloth or tissue.
- After cleaning please dry off any residual dampness with a soft cloth.
- If seat and cover make contact with toilet cleaners and or other aggressive cleaners, please immediately rinse with pure water.
- When using a toilet cleaner to clean the toilet, wash it off within 3 minutes. Seat and cover must be left in an upright position until all cleaning agents in the bowl has been flush away.
(If vapor from a toilet bowl cleaner enters the main unit. It might cause a malfunction.)

Parts Names

Main Display

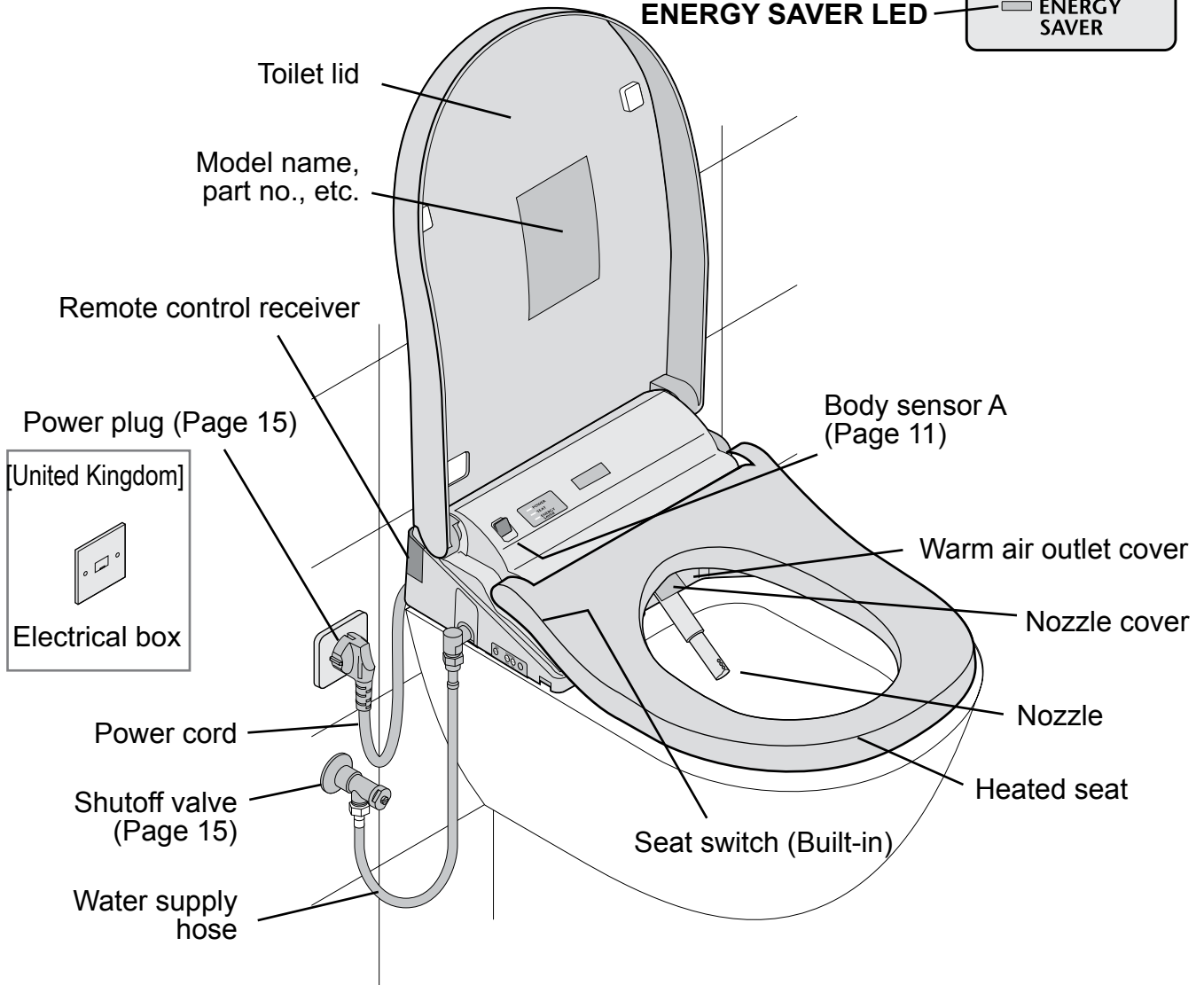
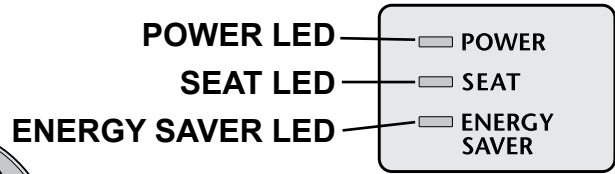

Left side of main unit

Control panel

Water filter drain valve (Page 35)

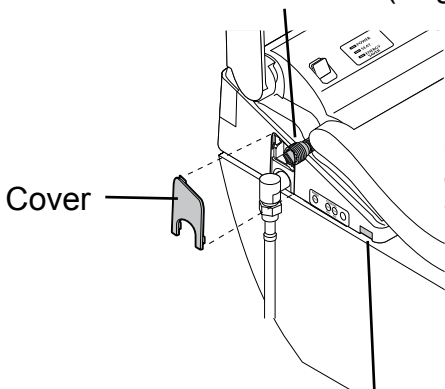

POWER ON/OFF

Night light

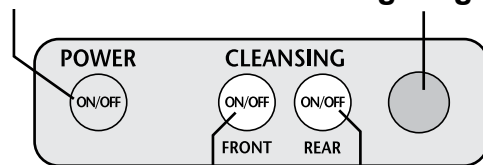

FRONT ON/OFF REAR ON/OFF

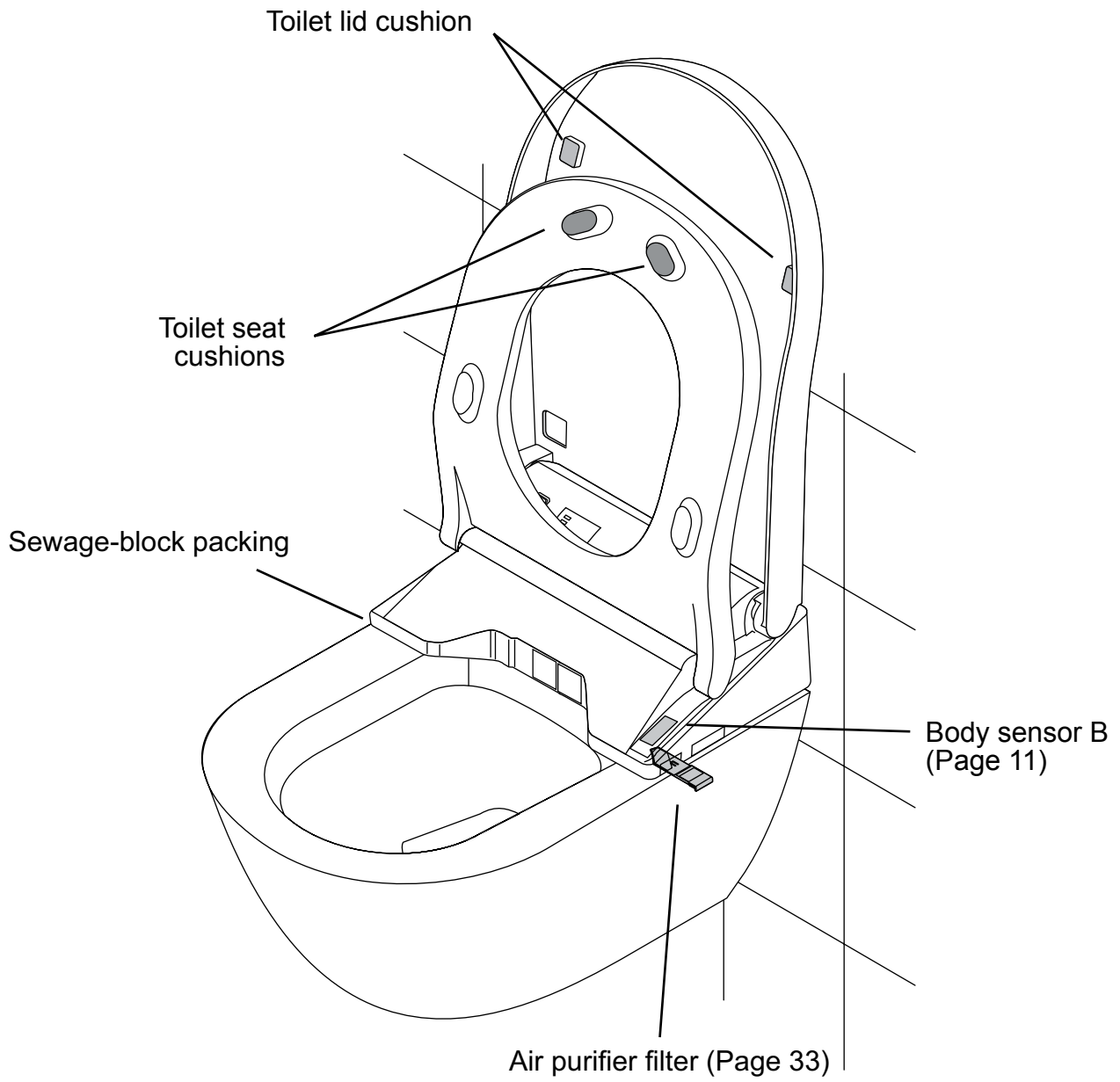

Right rear of main unit

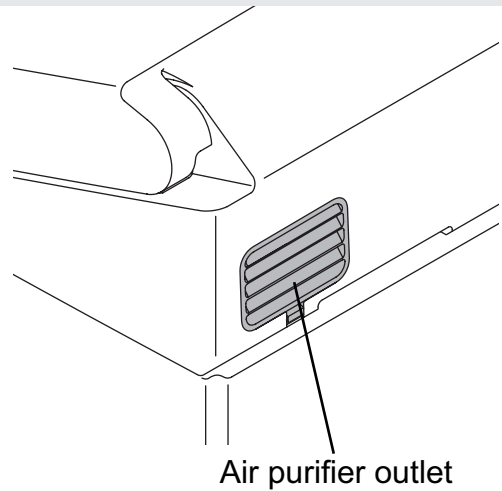

Preparation (Using the Product for the First Time)

1 Insert the battery

1. Remove the remote control from the hanger.

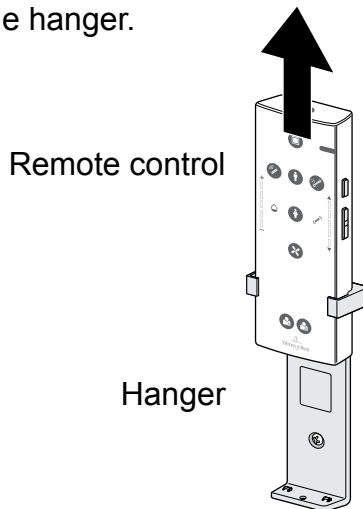

2. Open the battery cover and insert two AA batteries.

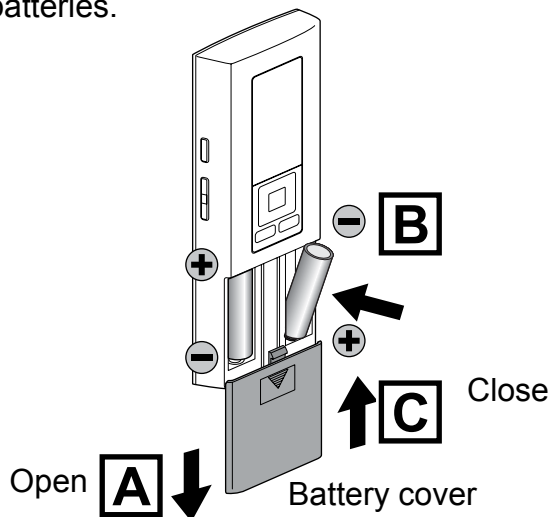

- When batteries are properly inserted, temperature levels appear on the display of the remote control (back side).
- The display goes out when no button on the remote control is pressed for 5 minutes or more.

3. Mount the remote control in the hanger.

About the batteries

- Use dry cell, alkaline batteries. Follow the instructions below to prevent the batteries from rupturing or leaking fluid.
- When replacing the batteries, use new batteries of the same brand.
- If you will not be using the remote control for a long time, remove the batteries.
- Do not use rechargeable batteries.

If the remote control is secured (for anti theft)

1. Remove the screw from the remote control fixture.

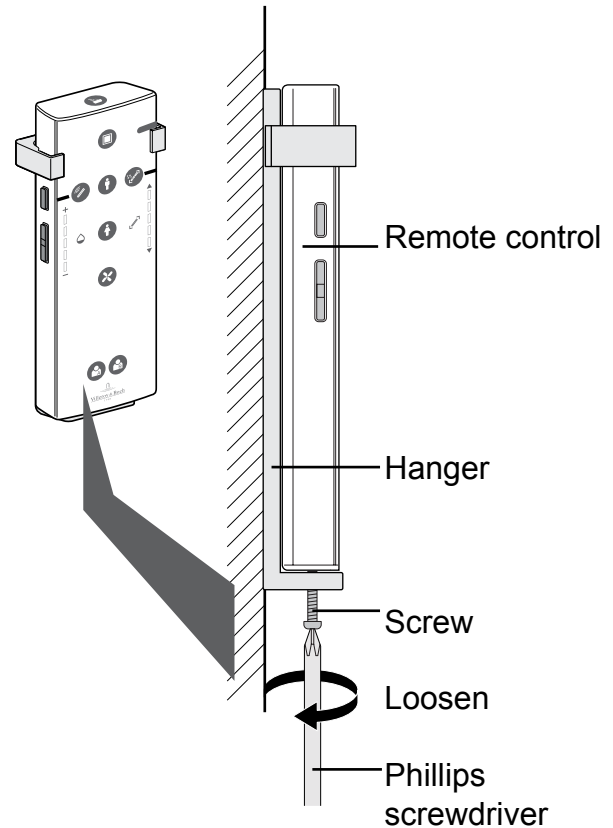

2. Remove the remote control from the hanger.

To secure the remote control again

Tighten the screw.
(Overtightening may cause damage to parts such as the hanger)

2 Turn on the power

1. Insert the power plug.
Switch the breaker on the distribution board to ON. (UK)
 - The Nozzle extends and then retracts

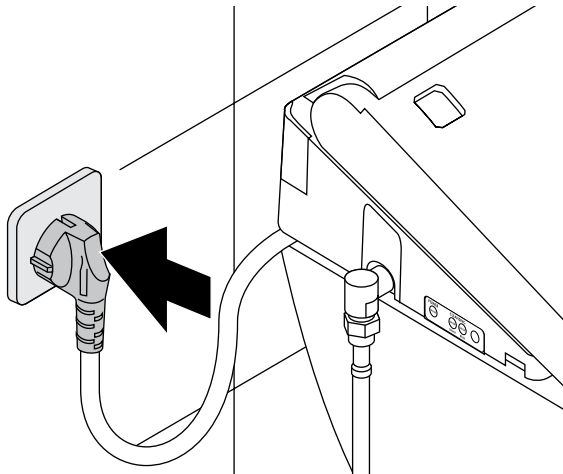

2. Check that the POWER LED on the main display is lit up.

- If it does not light up, press [POWER ON/OFF] to light it up.

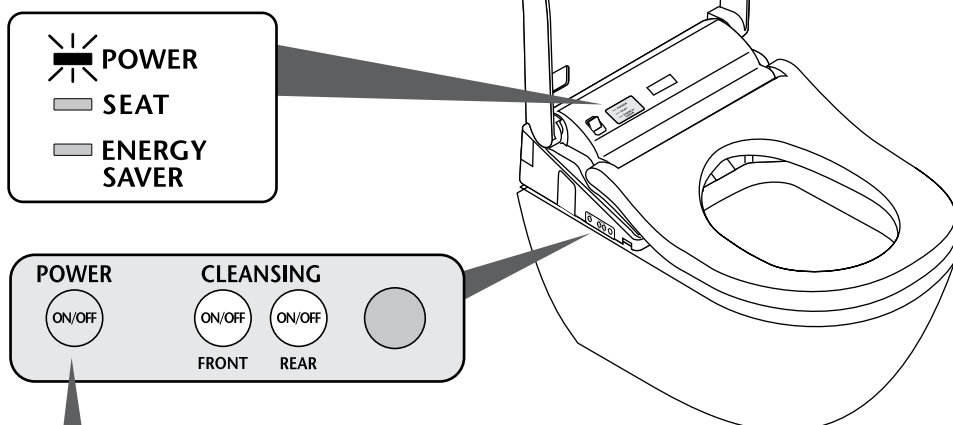

To turn the power „OFF“

Press [POWER ON/OFF] to turn the power off.

- The POWER LED goes off.

3 Open the shutoff valve

1. Fully open the shutoff valve.

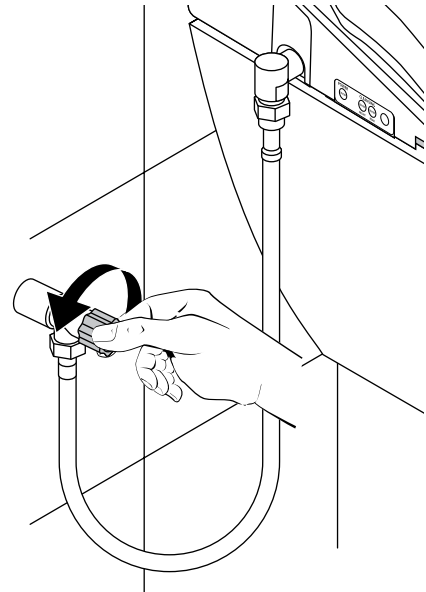

Basic Operations

Press a button on the remote control; a beep sounds when the main unit receives the signal

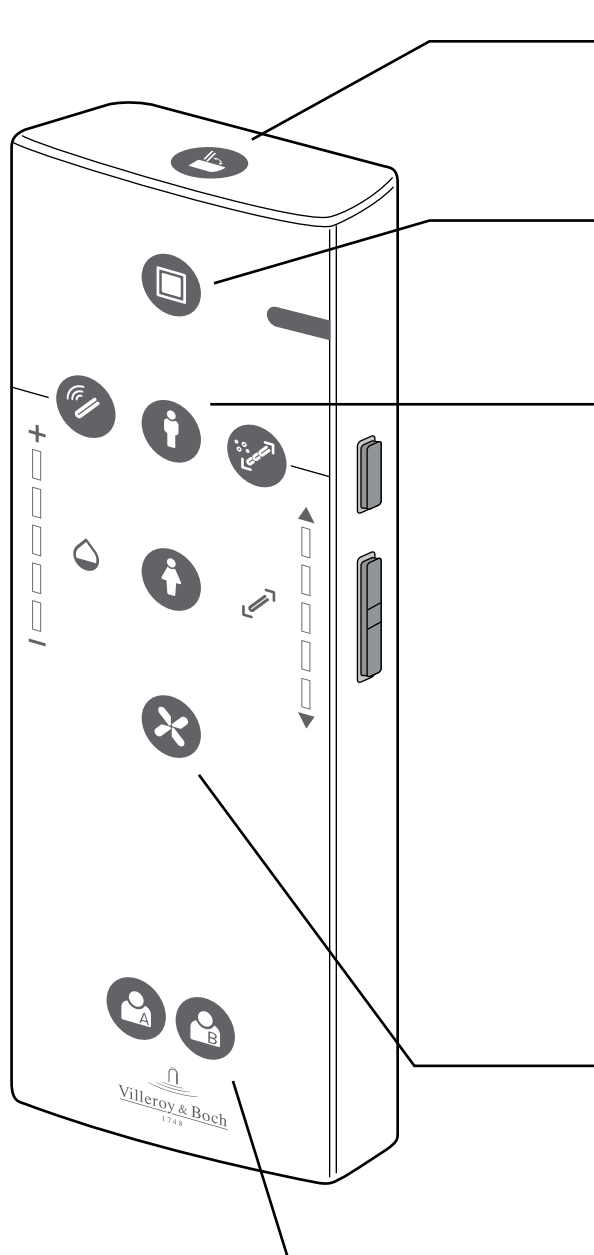

Opening and closing



[SEAT & LID OPEN/CLOSE]

Opens and closes the toilet seat.

Stopping



[STOP]

Stops the operation.

Cleanse

[REARWASH]

Cleanses your rear.



[SOFT]

Washes your rear with mild water pressure.

*The mode changes between [SOFT] (flickering) and [REARWASH] (steady on) each time the button is pressed.



[LADYWASH]

Serves as a bidet for ladies.

Drying



[DRYER]

Dries your rear.

Personal setting lock



[USER1] / [USER2]

You can store your preferred nozzle position, water pressure and water temperature a setting.

- To store a setting
While cleanse is in progress, set your preferred nozzle position, water pressure, and warm water temperature, and then press and hold [USER 1] or [USER 2] for 2 seconds or longer.
- To use

Press [USER 1] or [USER 2], and then press the button for the cleanse you want to use.

*The nozzle position and water pressure lamps will light up for about 10 seconds in their set positions, and the water temperature display switches.

Functions that operate when a button is pressed during „REARWASH“, „SOFT CLEANSE“ or „LADYWASH“.

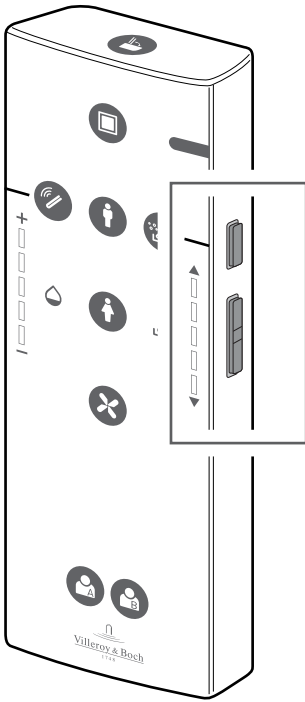

[OSCILLATING]

- The nozzle moves back and forth to wash your rear thoroughly.
- The setting changes between „ON“ and „OFF“ each time the button is pressed.

[POSITION]

- The nozzle position can be adjusted to the front or rear.
(„▲“: Moves to the front, „▼“: Moves to the rear)

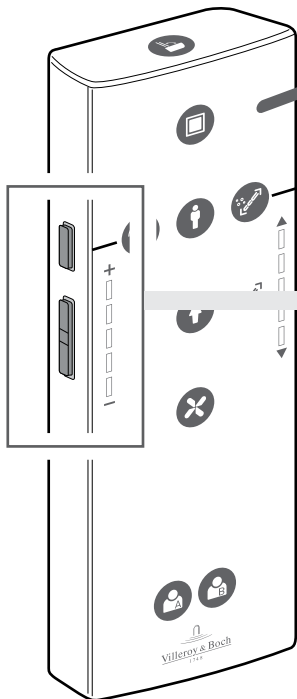

[PULSATING]

- Washes with the water pressure pulsating between soft and strong.
- The setting changes between „ON“ and „OFF“ each time the button is pressed.

[PRESSURE]

- The water pressure strength can be adjusted for cleanse functions such as REARWASH.(„-“: Softer, „+“: Stronger)

Note:

- Sitting back on the toilet seat makes it easier to adjust the nozzle position and to reduce splashing

Basic Operations (About the Menu Screen)

This section is an overview of the settings that can be configured with the remote control.

- See the corresponding pages for the detailed descriptions.

Remote control back side

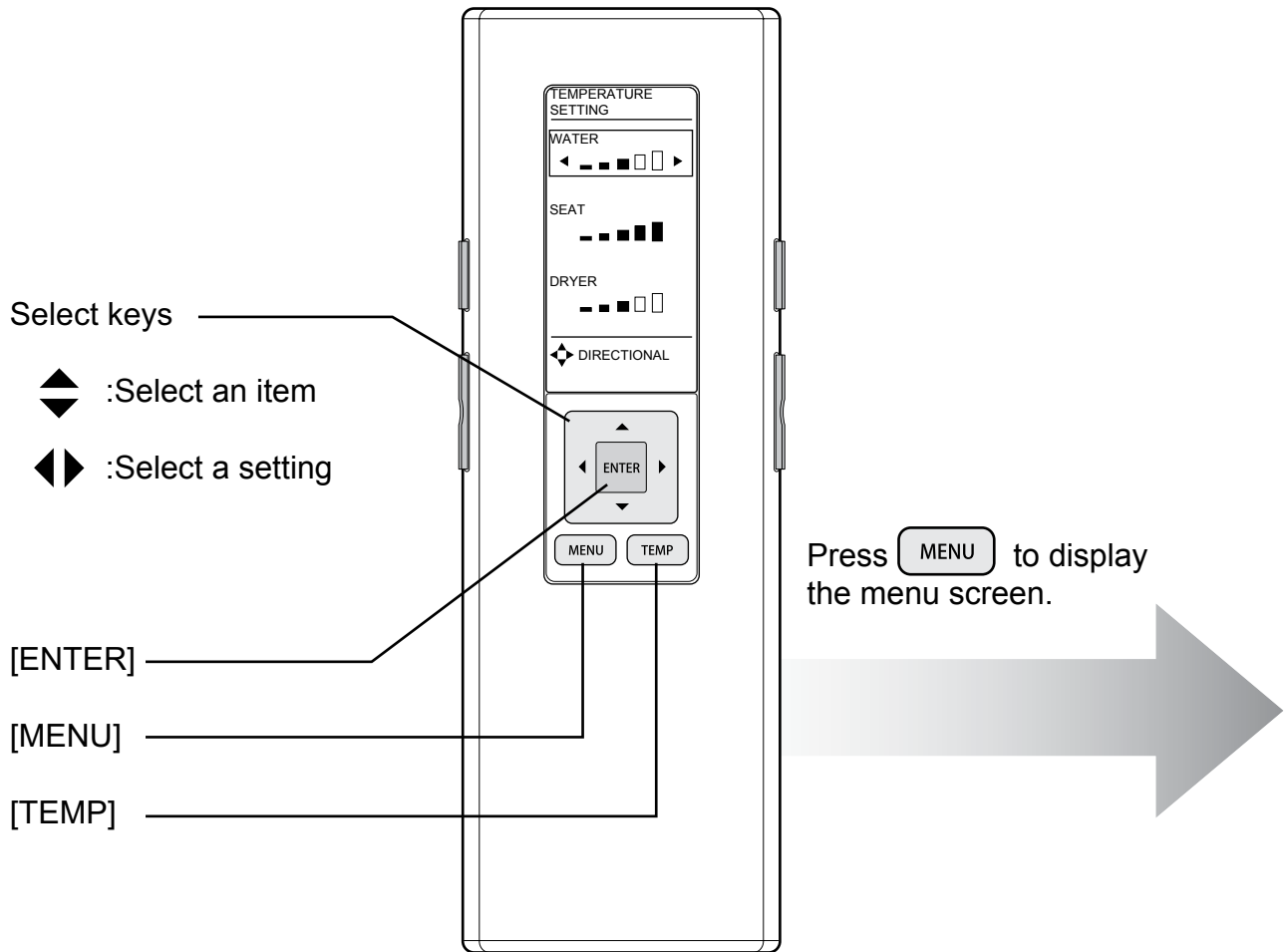

Setting lock

You can lock the settings so that you do not mistakenly operate the rear buttons while using the remote control.

How to Set (Page 44)

Display screen during setting lock





LEVEL 1

LEVEL 2

LEVEL 3

MENU 1/4

- 1. CLEANING
- 2. ENERGY SAVER
- 3. AUTO FUNCTIONS
- 4. OTHER SETTINGS

CLEANING 1/1

NOZZLE
CLEANING
MODE ON/OFF

ENERGY SAVER 1/2

- 1. AUTO ENERGY SAVER
◀ OFF ▶
- 2. TIMER SAVER
◀ OFF ▶

AUTO FUNCTIONS 1/3

- 1. AUTO OPEN/CLOSE
- 2. CLEANING
- 3. LIGHT

OTHER SETTINGS 1/3

- 1. BEEP
◀ ON ▶
- 2. SETTING LOCK
◀ ON ▶
- 3. PERSONAL SETTING LOCK
◀ ON ▶

AUTO OPEN/CLOSE 1/4

- 1. AUTO OPEN/CLOSE
◀ ON ▶
- 2. AUTO CLOSE WAITING TIME
◀ 90SEC ▶
- 3. AUTO OPEN WAITING TIME
◀ 15SEC ▶
- 4. SEAT/LID
◀ LID ▶

CLEANING 1/1

- 1. AIR PURIFIER
◀ ON ▶

LIGHT 1/1

- 1. NIGHT LIGHT
◀ ON ▶

Operation

Automatic Functions (Cleaning Features)

Various automatic functions are available, such as a toilet lid that opens and closes automatically.

- Operation under the initial settings is described below.

As you approach

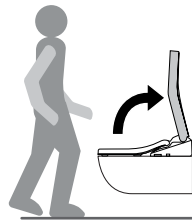

As you sit*2



As you stand up



Air purifier



Starts the Air purifier

Air purifier stops
→ It stops after about 2 minutes

Opening the toilet lid automatically AUTO OPEN/ CLOSE

When using the toilet seat

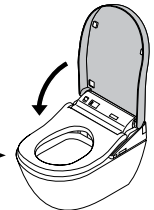
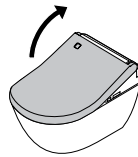

Toilet lid closes

(About 90 seconds after you stand up from the toilet seat.)

When standing-up to urinate

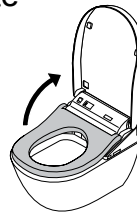
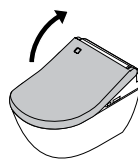

Toilet lid opens

*Open the toilet seat with the remote control.

Night light

Lights up in middle mode



Lights up in high mode



Lights up in middle mode (About 90 seconds)

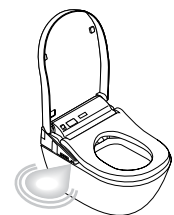

*2 Water comes out from around the nozzle.

**As you
move away**

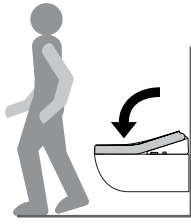

If dirt adheres to the nozzle during use, you can extend the nozzle to clean it.

- Cleaning the nozzle (Page 32)

Note

Changing settings

AIR PURIFIER
ON/OFF (Page 40)

- When the room temperature reaches about 30°C or higher, the sensor may not detect properly, preventing the toilet lid from opening. (Open and close manually.)
- When the toilet lid is closed with the remote control or by hand, it cannot open automatically for about 15 seconds. (Open and close manually.)
- When you do not sit on the toilet seat, or when you sit on it or stand in front of the toilet bowl briefly, it takes about 5 minutes before the lid close automatically.

- AUTO OPEN/CLOSE ON/OFF
- AUTO OPEN DELAY (15 seconds, 30 seconds or 90 seconds)
- AUTO CLOSE DELAY (25 seconds or 90 seconds)
- Automatically opening the toilet lid or both the toilet seat and toilet lid (Page 38)

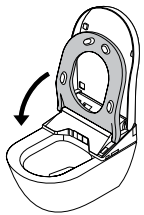

The toilet lid and toilet seat close

(About 90 seconds after the

user has moved about 30 cm away from the toilet seat.)

Lights up in low mode
(Goes out after about 5 seconds.)



- NIGHT LIGHT ON/OFF (Page 42)

Temperature Adjustment (Warm Water / Toilet Seat / Drying)

You can adjust the temperature levels or turn the settings to „OFF“.

1 Press **TEMP**

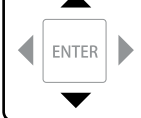
2 

Use  to select the item you want to set.

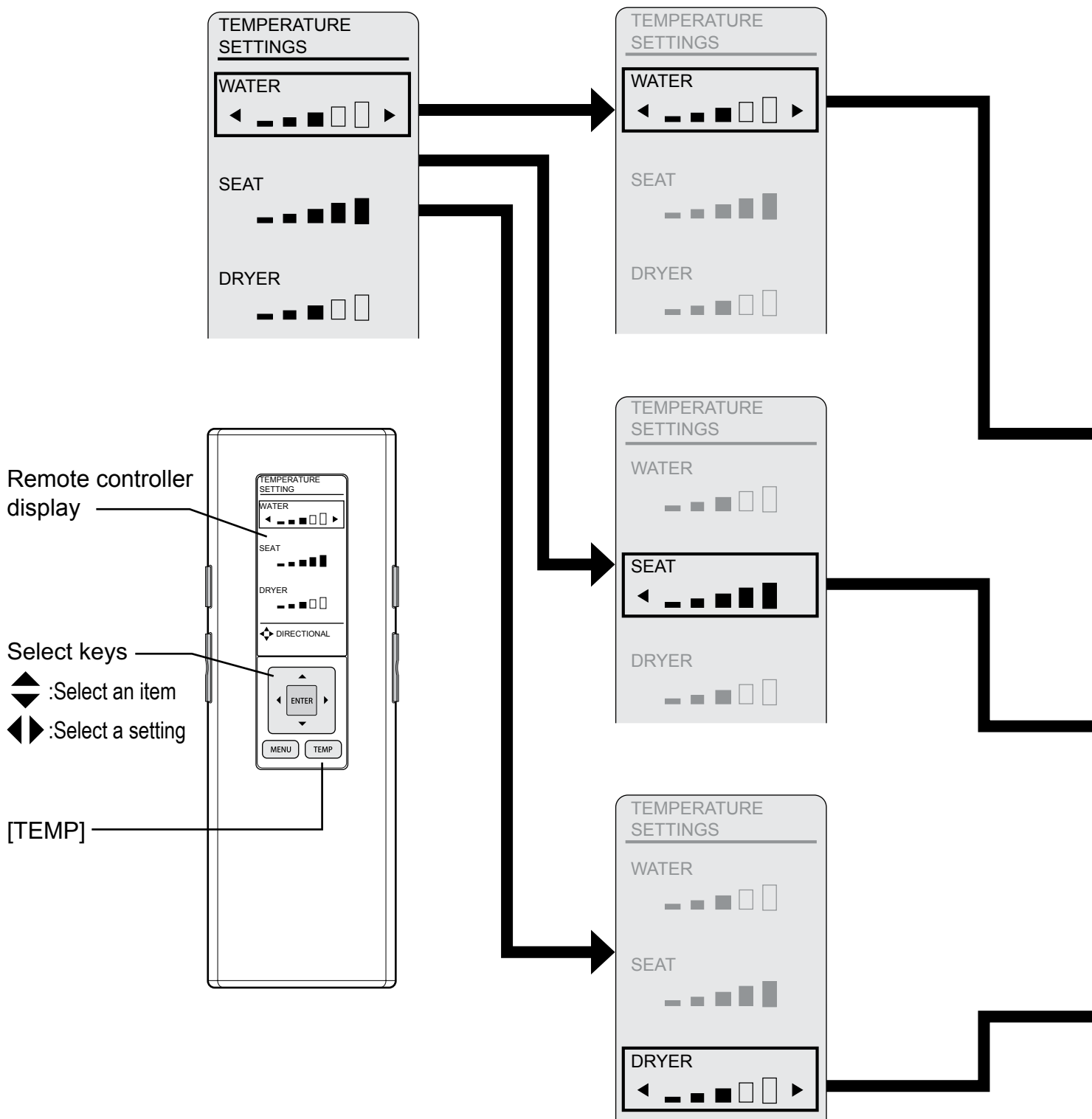

3

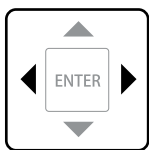

Use  to select the item you want to set.

<Settings complete>

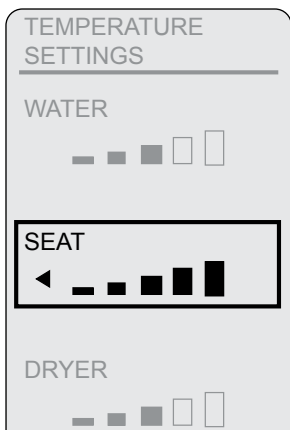

Warm water temperature

Press  until „OFF“ appears.

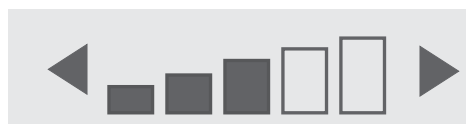

OFF  Low  High

Toilet seat temperature

Press  until „OFF“ appears.



OFF  Low  High

Drying air temperature



Low  High

* To prevent condensation, the water temperature does not drop below 20°C even when set to „OFF“.

Energy Saver Features (Type)

You can save energy by turning the toilet seat heater to a low temperature (or turning the heater „OFF“) during periods when the toilet will be used infrequently.

- It takes about 10 days for the product to determine the periods when it is used relatively less frequently.

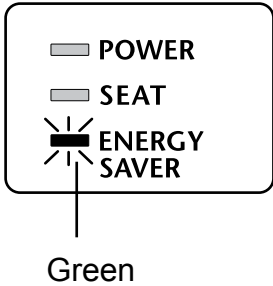
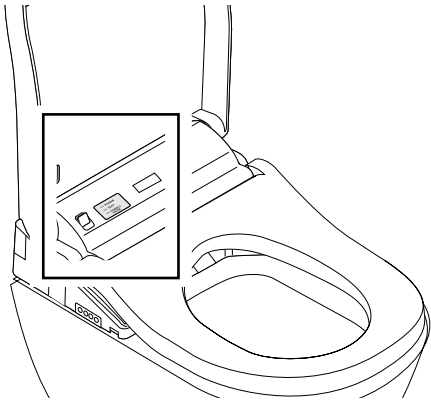
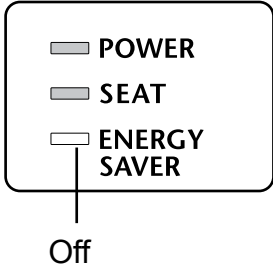
Type	Situation	When energy saver is set	
		Main Display	
AUTO ENERGY SAVER	<p>You want to save energy but dislike a cold toilet seat</p> <p>VICLEAN[®] detects time periods with infrequent use and lowers the toilet seat temperature automatically.</p>		→
TIMER ENERGY SAVER	<p>You want to save energy only for the preset duration of time.</p> <p>If you set the duration of time (3 hours, 6 hours or 9 hours) during which you want to save energy, the heater automatically turns off every day in the set time slot.</p>		→
AUTO ENERGY SAVER + TIMER ENERGY SAVER	<p>You want to save a lot of energy with auto energy saver and timer energy saver</p> <p>When both timer energy saver and auto energy saver are set, auto energy saver operates when timer energy saver is not operating.</p>	<p>When energy saver is not set</p> 	→

- Even if the toilet seat heater is set to „Low“ or „OFF“, the toilet seat is temporarily heated when you sit on it.

When energy saver is in operation		AM			PM		
Toilet seat heater		0	6	8	5	9	0
<p>Green</p> <p>Orange</p>	<p>Low</p>	<p>Example: Used infrequently from 9 pm to 6 am</p>					
		Low temperature ^{*2}	Set temperature ^{*1}			Low temperature ^{*2}	
<p>Green</p>	<p>OFF</p>	<p>Example: Set from 8 am to 5 pm</p>					
		Set temperature ^{*1}			Set temperature ^{*1}		
			OFF ^{*3}				
<ul style="list-style-type: none"> • During timer energy saver: Same LED indication as timer energy saver (See above) • During auto energy saver: Same LED indication as auto energy saver 	<p>Low</p> <p>OFF</p>	<p>Example: When timer energy saver and auto energy saver are used together</p>					
		Low temperature ^{*2}	Set temp. ^{*1}		Set temp. ^{*1}		Low temperature ^{*2}
			OFF ^{*3}				

Operation

*1 The toilet seat temperature set on Page 22.

*2 The time period when the toilet seat heater is set to a low temperature by the auto energy saver.

*3 The time period when the toilet seat heater is „OFF“.

To set energy saver Page 26 / 27

Energy Saver Features (How to set)

Set the timer energy saver at the time you want to start it.

1 Press **MENU**

2 Use **ENTER** to select „ENERGY SAVER“ and then press **[ENTER]**

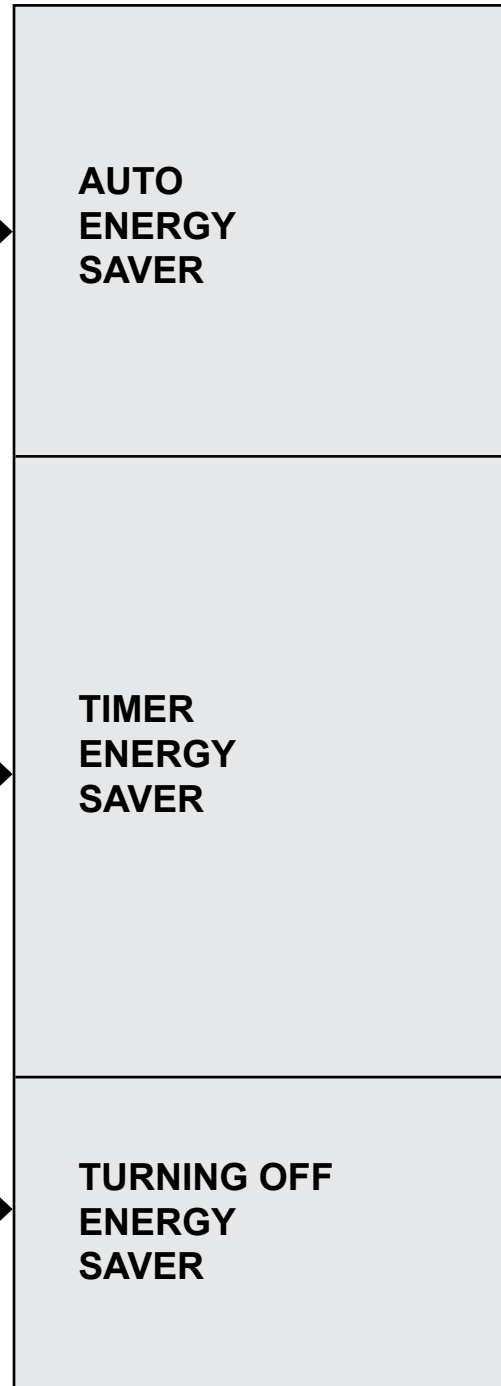
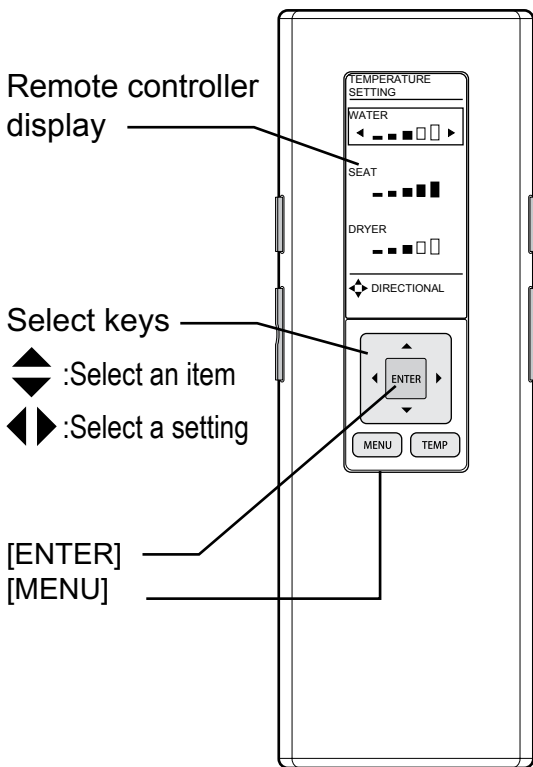
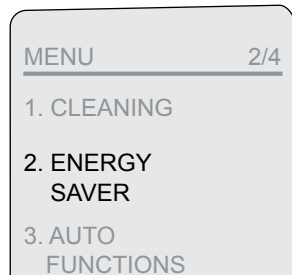

When energy saver is set, the ENERGY SAVER LED (green) lights up.

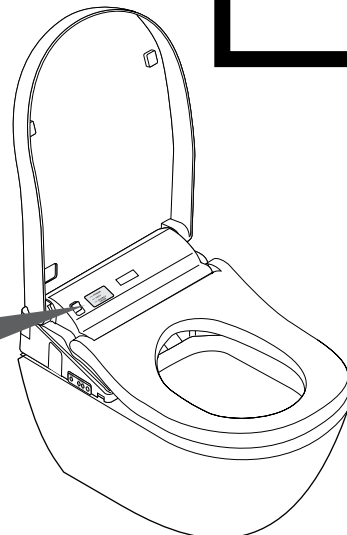
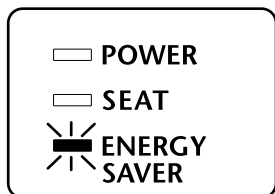



3 Use  to select „AUTO ENERGY SAVER“.

4 Use  to select „ON/OFF“ and then press [ENTER].

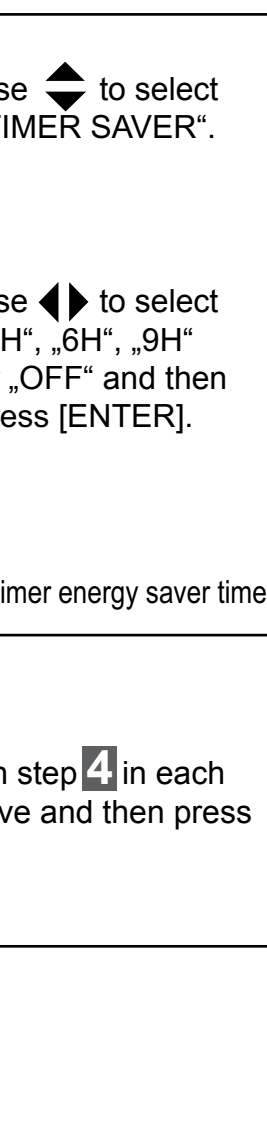
Press  to return



3 Use  to select „TIMER SAVER“.

4 Use  to select „3H“, „6H“, „9H“ or „OFF“ and then press [ENTER].

Press  to return

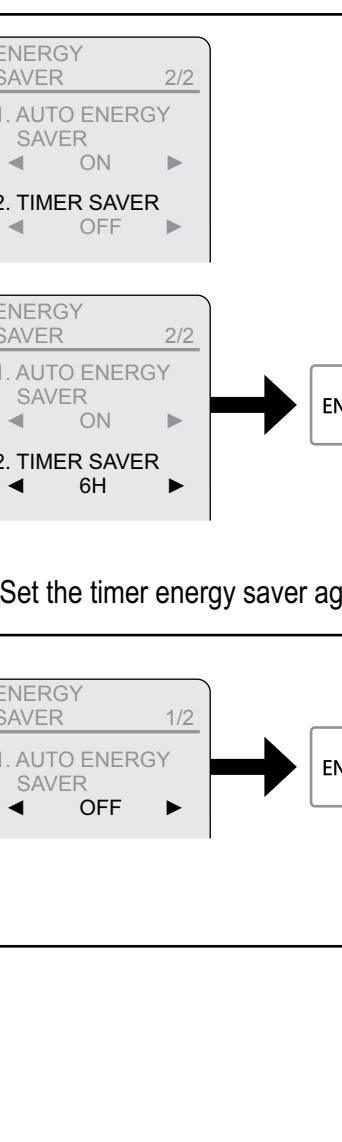

- To change the timer energy saver time → Set the timer energy saver again at the time you want to start it.

Select „OFF“ in step **4** in each procedure above and then press [ENTER].

Press  to return

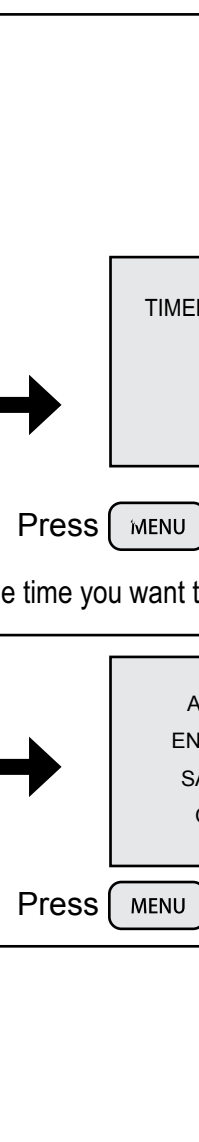

Maintenance



WARNING

Always disconnect the power plug from the outlet before cleaning, maintenance or inspection.

Always switch the breaker on the distribution board to OFF. (UK)

- Failure to do so may cause electrical shock or malfunction.
- * Except when using „Nozzle cleaning“

[United Kingdom]

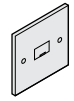

Electrical box



Periodically remove dust from the blades and other parts of the power plug.

- Disconnect the plug and wipe it with a dry cloth.
- Fully insert the power plug.
- When disconnecting, hold the main body of the power plug.
 - Pulling the cord may damage the plug or cord.

Power plug (Perform monthly)

- 1** Disconnect the power plug and wipe it with a **dry** cloth.

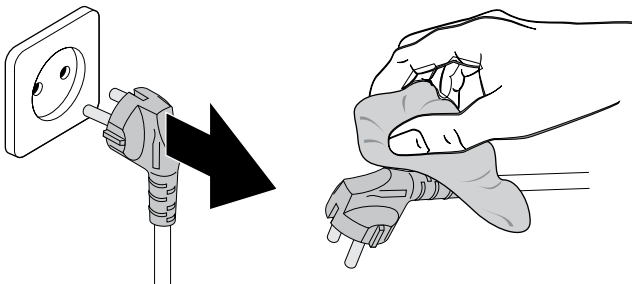

- 2** Insert the power plug.

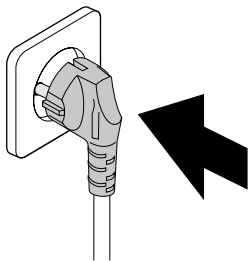

Power plug (Page 15)

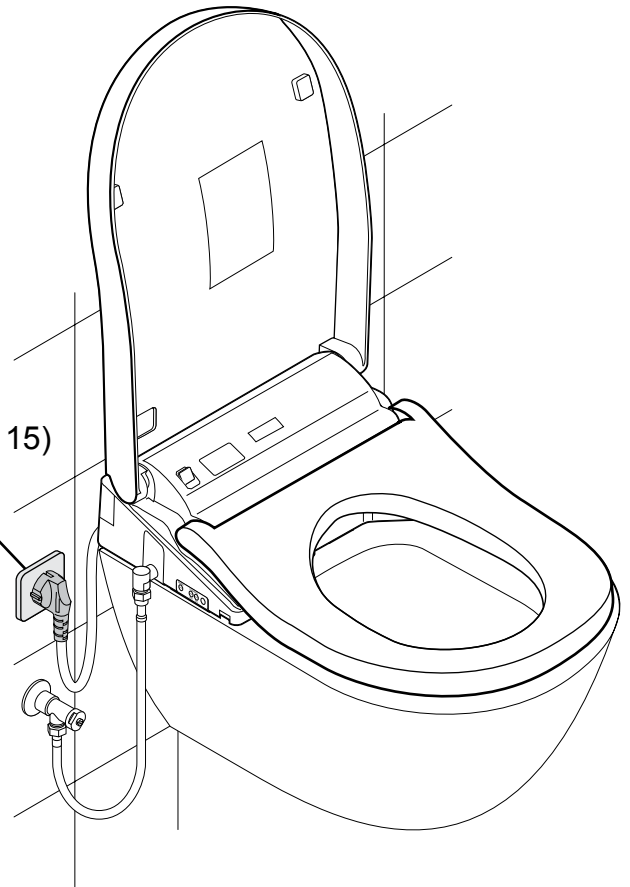

After the power plug is inserted and the breaker of the distribution board is switched on, the toilet lid does not open automatically for about 10 to 60 seconds. (Because it is preparing for operation.)
Open and close manually.



Do not use a dry cloth or toilet paper on plastic parts.
(May cause damage.)

Main unit (Perform daily)



Soft cloth soaked in water



- Toilet paper
- Dry cloth
- Nylon scrubbing pads
(May cause damage.)

1 Unplug the power plug. (Page 15)
Switch the breaker on the distribution board to OFF. (UK)

2 Wipe with a soft cloth that has been soaked in water and wrung-out thoroughly.

For heavy dirt

- Wipe with a soft cloth soaked in diluted, neutral kitchen detergent, and then wipe with a soft cloth soaked in water.



- Neutral kitchen detergent



- Paint thinner
- Benzene
- Powdered cleanser

3 Insert the power plug. (Page 15)
Switch the breaker on the distribution board to ON. (UK)

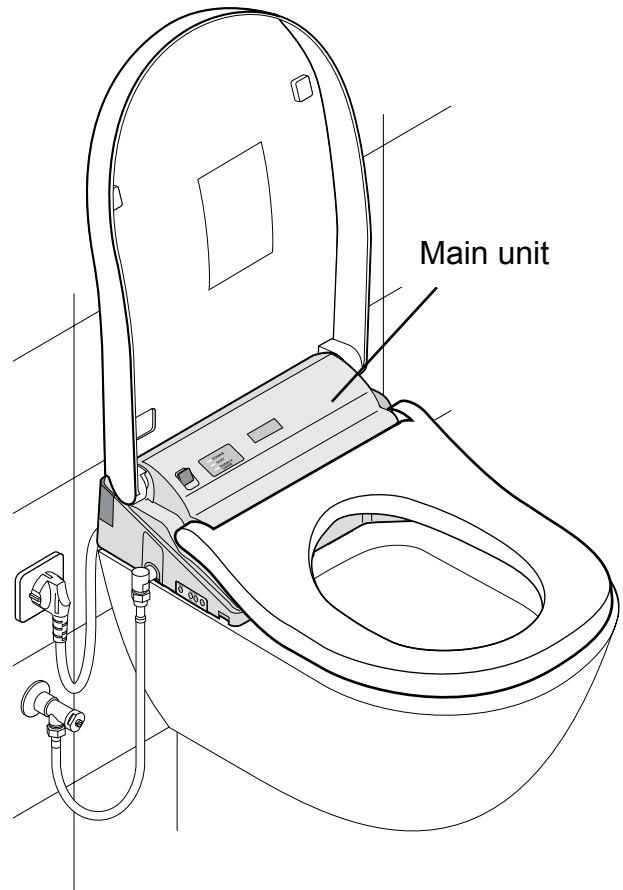

Attention!

- VICLEAN[®] is an electric appliance. Be careful not to let water seep inside or leave detergent in the gap between the main unit and toilet bowl. (May damage plastic parts or cause a malfunction.)
- When using a toilet cleaner to clean the toilet, wash it off within 3 minutes and leave the toilet seat and toilet lid open.
- Wipe off any cleaner that remains on the toilet bowl. (If vapor from a toilet bowl cleaner enters the main unit, it may cause a malfunction.)
- Do not push or pull the nozzle cover or the warm air dryer cover with undue force. (May cause damage or malfunction.)

Maintenance

Gap between the main unit and the toilet lid (Perform monthly)

The toilet lid can be removed for thorough cleaning.

- 1** Unplug the power plug. (Page 15)
Switch the breaker on the distribution board to OFF. (UK)

A : Pull the left side outward.



B : Disconnect the hinge from the pin and pull up.



C : Disconnect the right side.

Wipe with a soft cloth that has been soaked in water and wrung-out thoroughly.

- 2** Reinstall the toilet lid.

D : Join the pin and the hinge on the right side.



A : While pulling out the left side,



E : Mount by joining the hinge with the pin.
* Be careful not to pinch your fingers.

- 3** Insert the power plug. (Page 15)
Switch the breaker on the distribution board to ON. (UK)

Open and close the toilet lid to check the reinstallation

Removing and Reinstalling

Hold with both hands

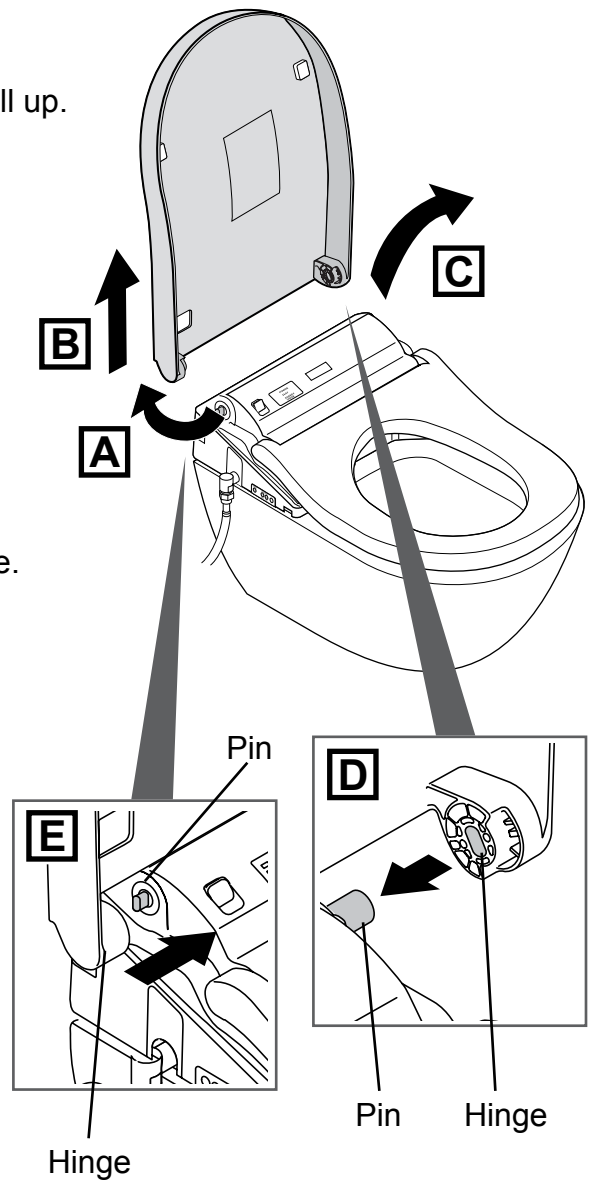

Air purifier filter (Perform monthly)

If you notice odors

1 Unplug the power plug. (Page 15)
Switch the breaker on the distribution board to OFF. (UK)

2 Remove the air purifier filter.
• Hold the knob and pull outward.
• Do not pull with undue force. (May cause damage or malfunctions)

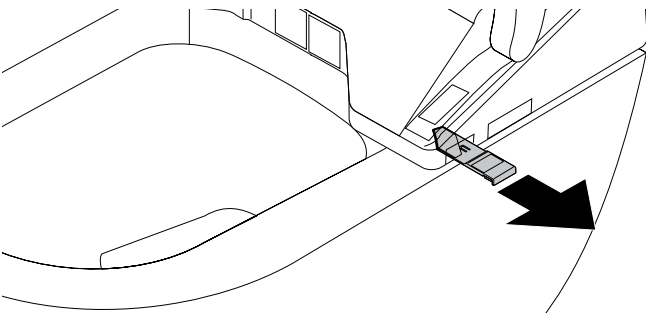

3 Clean with a tool such as a toothbrush.
• When washing with water, dry off all water before mounting.

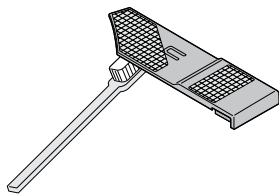

4 Mount the air purifier filter.
• Push firmly until a click sound is heard.

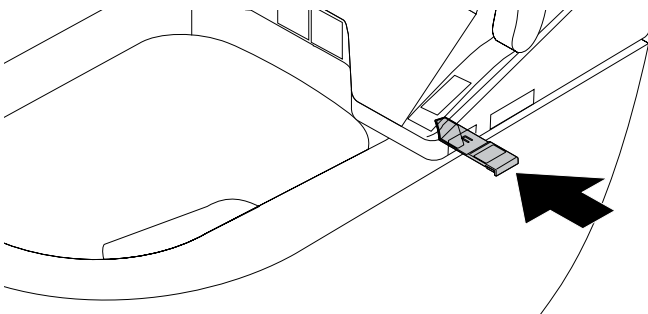

5 Insert the power plug. (Page 15)
Switch the breaker on the distribution board to ON. (UK)

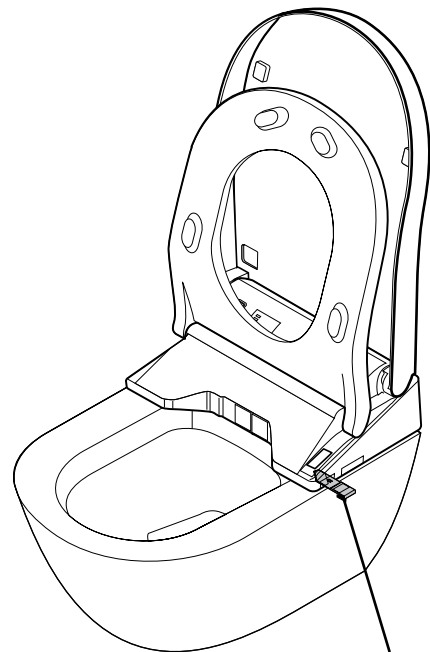

Air purifier filter

Maintenance

Nozzle (Perform monthly)

Nozzle cleaning - If you notice dirt

- 1** Extend the nozzle.
 - Operate with the buttons on the back side of the remote control.
 - (1) Press [MENU].
 - (2) Use  to select „CLEANING“.

Press [ENTER].

 - (3) Use  to select „NOZZLE CLEANING MODE ON/OFF“.

Press [ENTER].

 - The nozzle extends and water sprays out for cleaning.
 - The nozzle automatically retracts after about 5 minutes.

- 2** Wipe with a soft, wet cloth.
 - Do not pull, push or press the nozzle with excessive force.
(May cause damage or malfunction.)

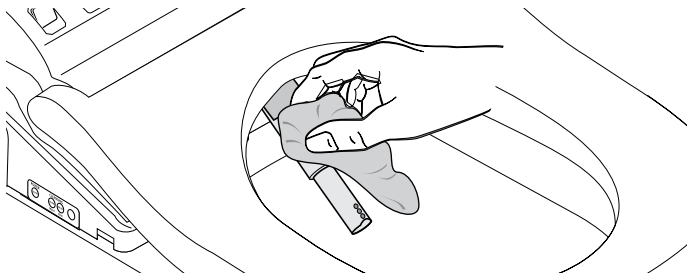

- 3** Press [STOP] on the front side of the remote control.
 - The nozzle retracts.

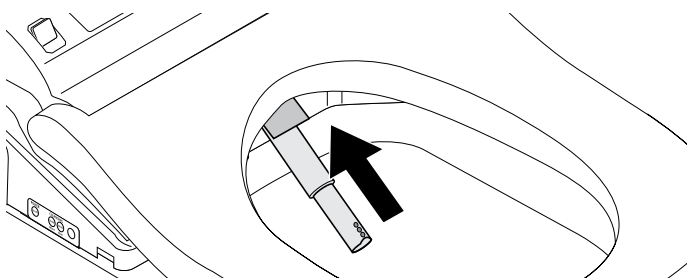

Soft cloth soaked in water



- Toilet paper
- Dry cloth
- Nylon scrubbing pads
(May cause damage.)

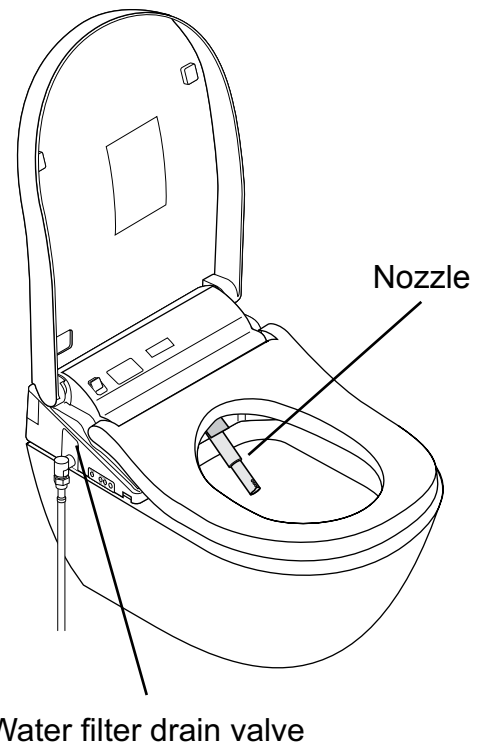

Water Filter Drain Valve (Perform once every 6 months)

If you think the water pressure has weakened

- 1** Close the shutoff valve.
- The water supply stops.

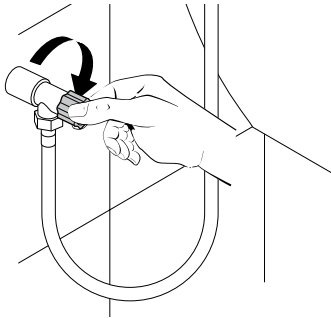

CAUTION



Do not remove the water filter drain valve while the shutoff valve is open. (Otherwise, water may leak out)

- 2** Extend the nozzle.
- Operate with the buttons on the back side of the remote control.

(1) Press [MENU].

(2) Use  to select „CLEANING“.

Press [ENTER].

(3) Use  to select „NOZZLE CLEANING MODE ON/OFF“.

Press [ENTER] to extend the nozzle.

Press [ENTER] again to retract the nozzle.

(Release the pressure from the water supply pipe.)

- 3** Unplug the power plug. (Page 15)
Switch the breaker on the distribution board to OFF. (UK)

- 4** Remove the cover and water filter drain valve.
- Loosen with a flat-head screwdriver and then pull.

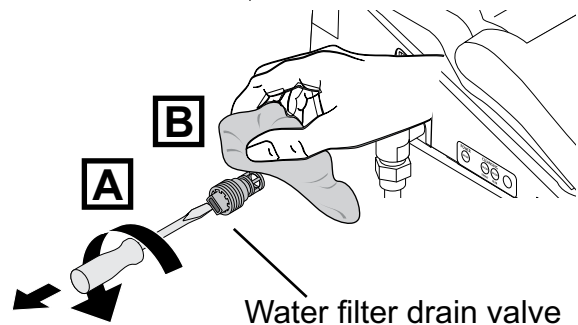
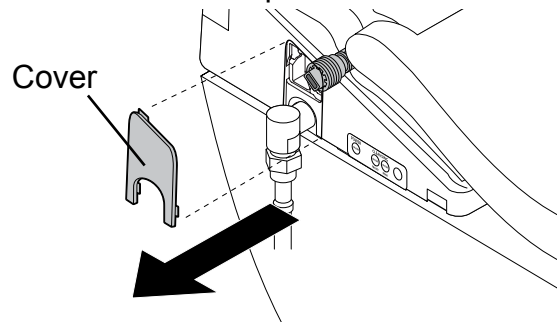

- 5** Clean with a tool such as a toothbrush.
- Also, remove any dust from inside the hole of the water filter drain valve.

- 6** Reinstall the water filter drain valve and cover.

- Insert the water filter drain valve and tighten it securely with a flat-head screwdriver.

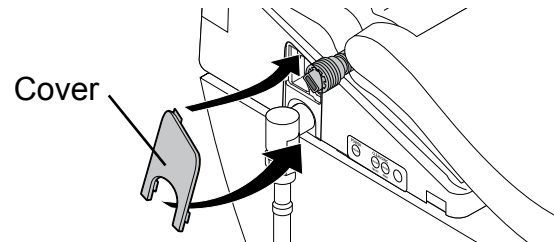

- 7** Insert the power plug. (Page 15)
Switch the breaker on the distribution board to ON. (UK)

- 8** Open the shutoff valve. (Page 15)

Changing Settings (Setting List)

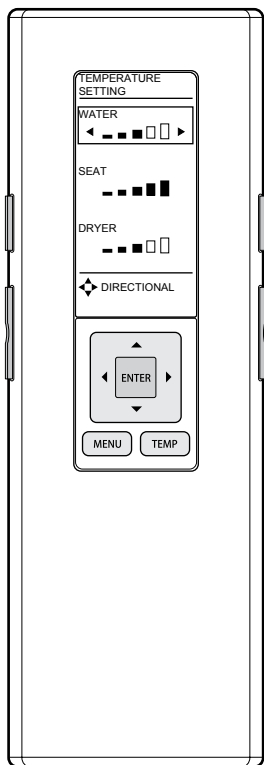

Setting Types		
AUTO FUNCTIONS	AUTO OPEN/ CLOSE	AUTO OPEN/ CLOSE
		AUTO CLOSE WAITING TIME
		AUTO OPEN WAITING TIME
		SEAT/LID
	CLEANING	AIR PURIFIER
	LIGHT	NIGHT LIGHT
OTHER SETTINGS	BEEP	
	PERSONAL SETTING LOCK	
	SETTING LOCK	

Setting Types	Available Settings*	Setting Ref. Page
<ul style="list-style-type: none"> ● Set whether or not to open the toilet lid automatically 	ON/OFF	Page 38
<ul style="list-style-type: none"> ● Change the amount of time before the lid/ seat closes automatically 	25SEC/90SEC	
<ul style="list-style-type: none"> ● Change the amount of time after which the lid/ seat opens automatically upon closing it with hands 	15SEC/30SEC/90SEC	
<ul style="list-style-type: none"> ● Automatically open and close the toilet lid/ Automatically open and close the toilet seat and toilet lid 	LID/SEAT · LID	
<ul style="list-style-type: none"> ● Set whether or not to deodorize automatically after sitting on the toilet seat 	ON/OFF	Page 40
<ul style="list-style-type: none"> ● Set whether or not to use the night light 	ON/OFF	Page 42
<ul style="list-style-type: none"> ● Set whether or not to make a beep sound 	ON/OFF	Page 44
<ul style="list-style-type: none"> ● Set whether or not to use the personal setting lock 	ON/OFF	
<ul style="list-style-type: none"> ● Set whether or not to use the setting lock 	ON/OFF	

*The black text is the initial setting.

Changing Settings (AUTO OPEN/CLOSE)

1 Press **MENU**

2 Use **⬆** to select „AUTO FUNCTIONS“ and then press **[ENTER]**

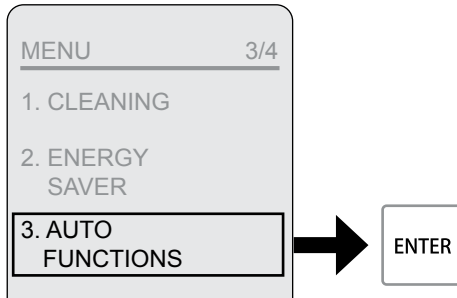

3 Use **⬆** to select „AUTO OPEN/CLOSE“ and then press **[ENTER]**

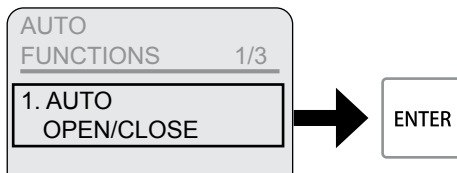

Set whether or not to open the toilet lid automatically

AUTO OPEN/CLOSE

Change the time before the lid/seat closes automatically (25 SEC or 90 SEC)*²

AUTO CLOSE WAITING TIME*¹

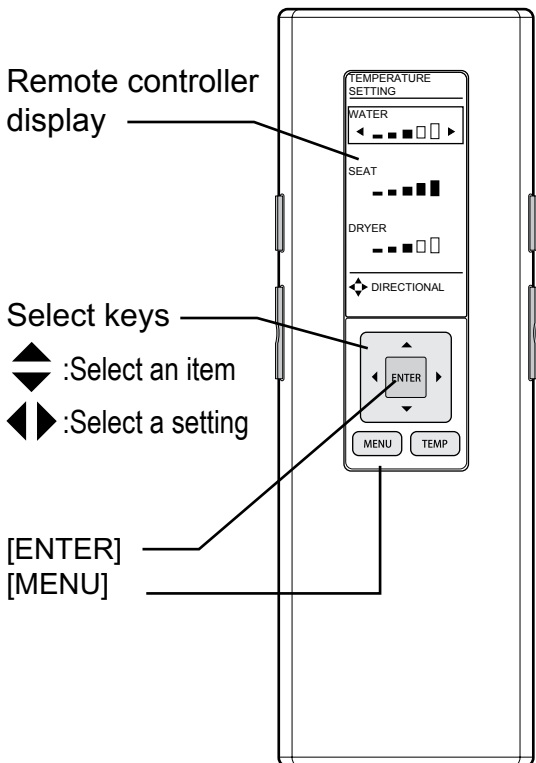

Items set on this display

1. AUTO OPEN/CLOSE
2. AUTO CLOSE WAITING TIME

4

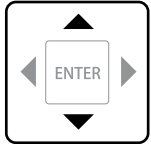

Use  to select „AUTO OPEN/CLOSE“.

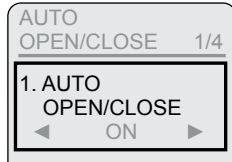

5

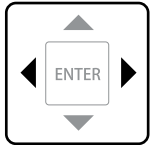

Use  to select „ON/OFF“ and then press [ENTER].

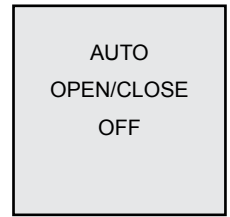
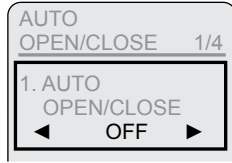

Press  to return

4

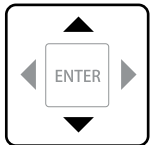

Use  to select „AUTO CLOSE WAITING TIME“.

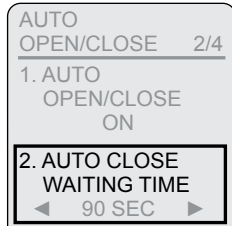

5

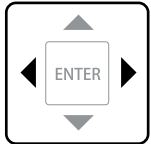

Use  to select „25SEC“ or „90SEC“ and then press [ENTER].

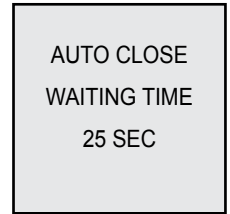
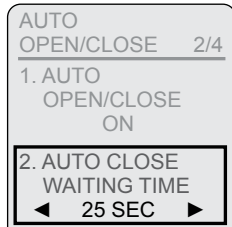

Press  to return

*1 This operation is not available when the AUTO OPEN/CLOSE is „OFF“.

*2 When set to 25 seconds, the lid/seat does not open automatically for about 15 seconds after closing automatically.

Changing Settings (AUTO OPEN/CLOSE)

1 Press **MENU**

2 Use **◀▶** to select „AUTO FUNCTIONS“ and then press **[ENTER]**

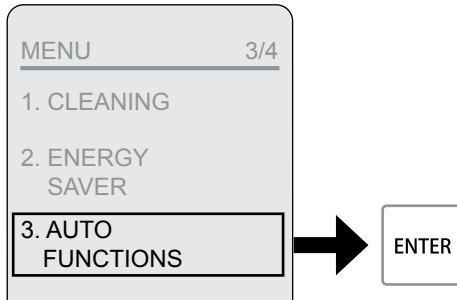

3 Use **◀▶** to select „AUTO OPEN/CLOSE“ and then press **[ENTER]**

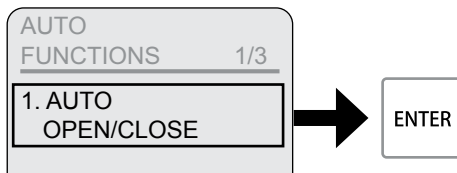

Change the time period till automatic opening (15 SEC, 30 SEC or 90 SEC) (After closing manually)

AUTO OPEN WAITING TIME*1

Automatically open and close the toilet lid only/ Automatically open and close the toilet seat and toilet lid*2

SEAT/LID*1

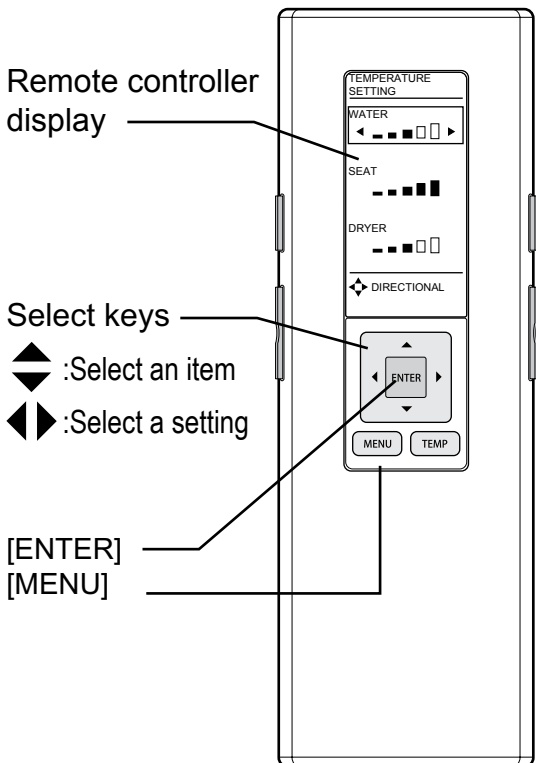

Items set on this display

1. AUTO OPEN WAITING TIME
2. SEAT/LID

4

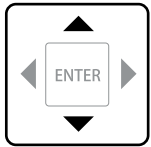

Use to select „AUTO OPEN WAITING TIME“.

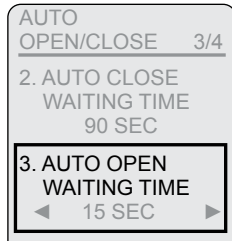

5

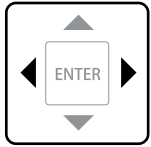

Use to select „15SEC“, „30SEC“ or „90SEC“ and then press [ENTER].

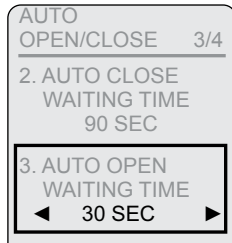

Press to return

4

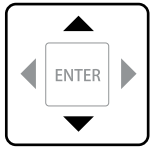

Use to select „SEAT/LID“.

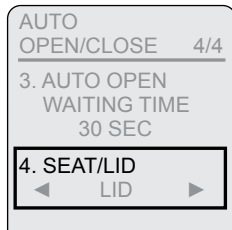

5

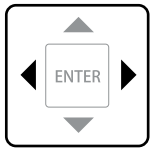

Use to select „LID“ or „SEAT • LID“ and then press [ENTER].

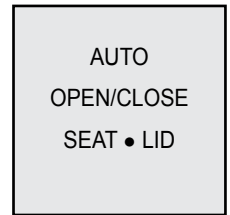
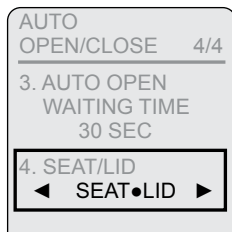

Press to return

*1 This operation is not available when the AUTO OPEN/CLOSE is „OFF“.

Changing Settings (CLEANING)

1 Press **MENU**

2 Use **◀▶** to select „AUTO FUNCTIONS“ and then press **[ENTER]**

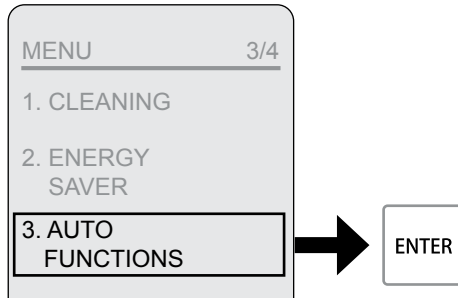

3 Use **◀▶** to select „CLEANING“ and then press **[ENTER]**

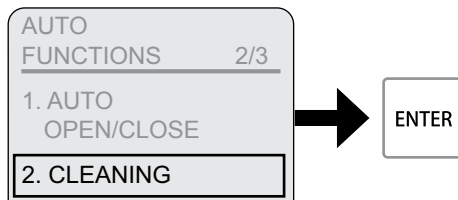

Set whether or not to deodorize automatically after sitting on the toilet seat

AIR PURIFIER

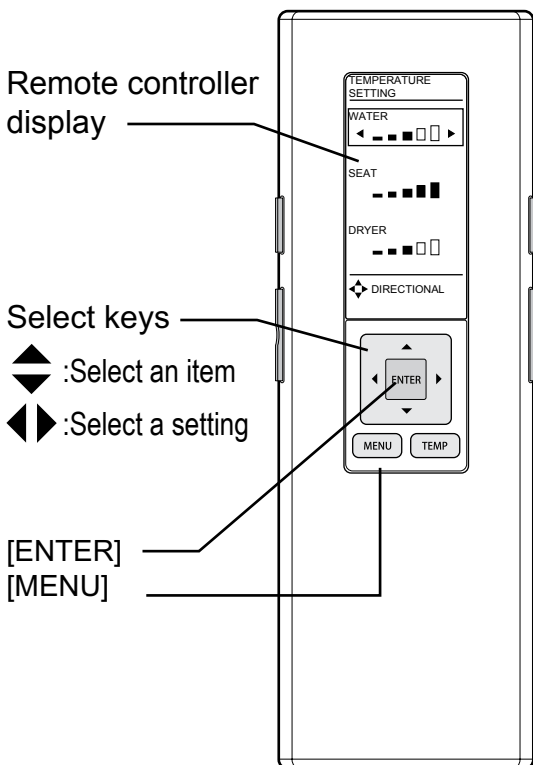

Items set on this display
1. AIR PURIFIER

4

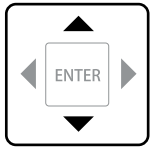

Use  to select „AIR PURIFIER“.



5

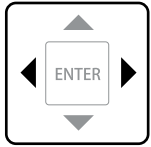

Use  to select „ON/OFF“ and then press [ENTER].

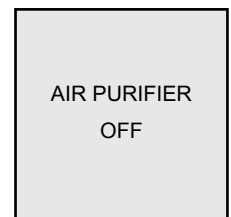

Press  to return

Changing Settings (LIGHT)

1 Press **MENU**

2 Use **◀▶** to select „AUTO FUNCTIONS“ and then press **[ENTER]**

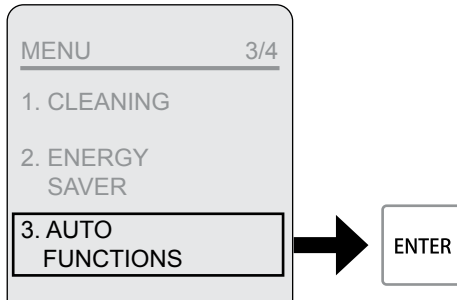

3 Use **◀▶** to select „LIGHT“ and then press **[ENTER]**

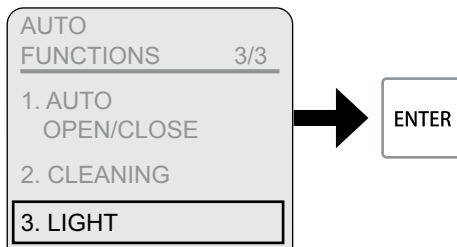

Set whether or not to use the night light

NIGHT LIGHT

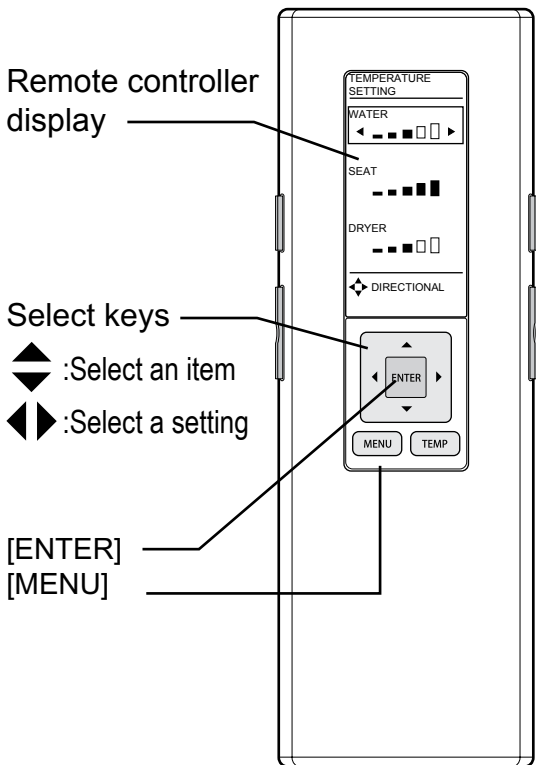

Items set on this display

1. NIGHT LIGHT

4

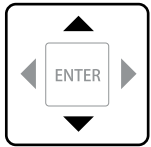

Use  to select „NIGHT LIGHT“.

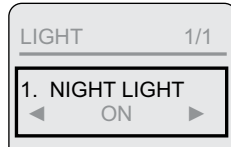

5

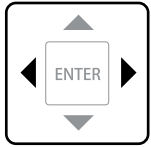

Use  to select „ON/OFF“ and then press [ENTER].

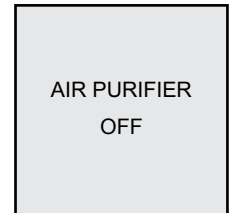
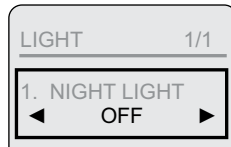

Press  to return

Changing Settings (OTHER SETTINGS)

1 Press **MENU**

2 Use **ENTER** to select „OTHER SETTINGS“ and then press **[ENTER]**

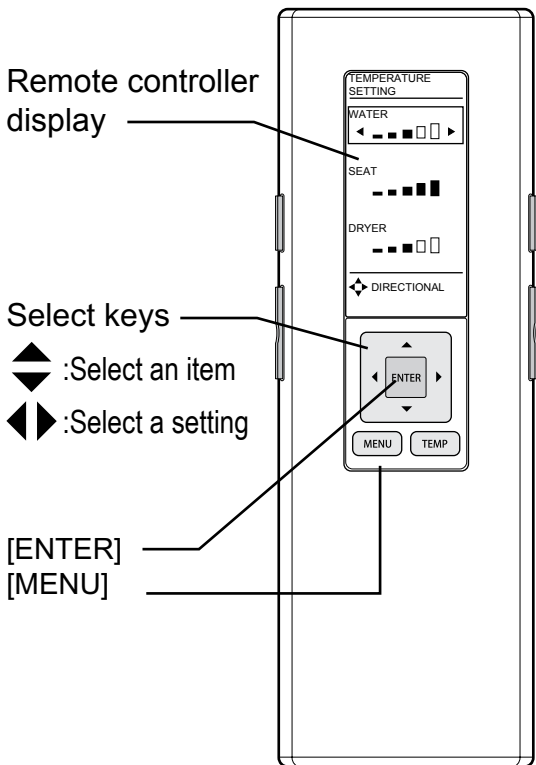
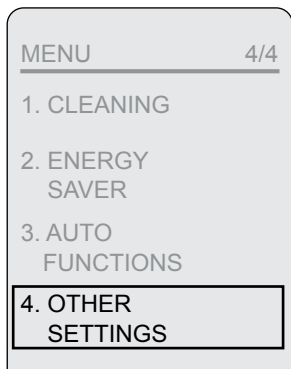

Items set on this display
 1. BEEP
 2. PERSONAL SETTING LOCK
 3. SETTING LOCK

Set whether or not to make a beep sound
BEEP

Set whether or not to use the setting lock
SETTING LOCK

Set whether or not to use the personal setting lock
PERSONAL SETTING LOCK

3

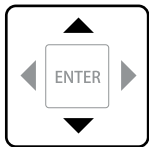

Use  to select „BEEP“.

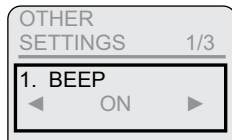

4

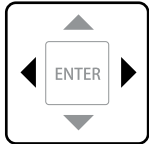

Use  to select „ON/OFF“ and then press [ENTER].

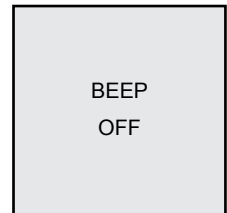
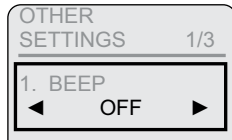

Press  to return

3

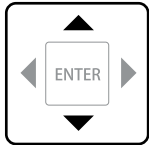

Use  to select „SETTING LOCK“.

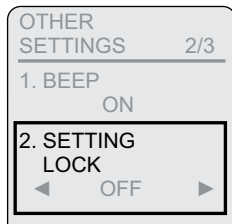

4

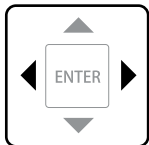

Use  to select „ON/OFF“ and then press [ENTER].

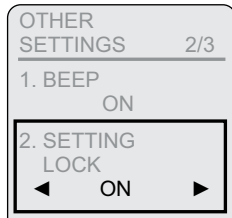

Press  to return

5

Check the displayed screen.

Display screen during setting lock



Cancellation method:
Press [ENTER] for 2 seconds or longer.

*If you want to relock after cancellation, reconFigure the setting.

3

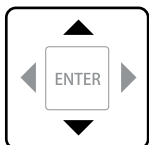

Use  to select „SETTING LOCK“.

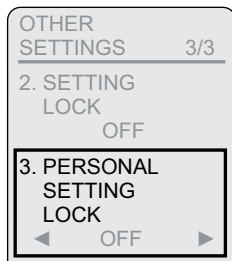

4

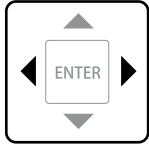

Use  to select „ON/OFF“ and then press [ENTER].

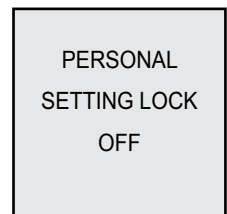
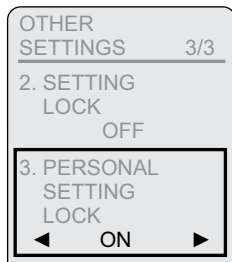

Press  to return

What to Do?

If you cannot operate with the remote control

- Operation is also possible using the buttons on the control panel.
- The batteries may have worn out. Replace the batteries.

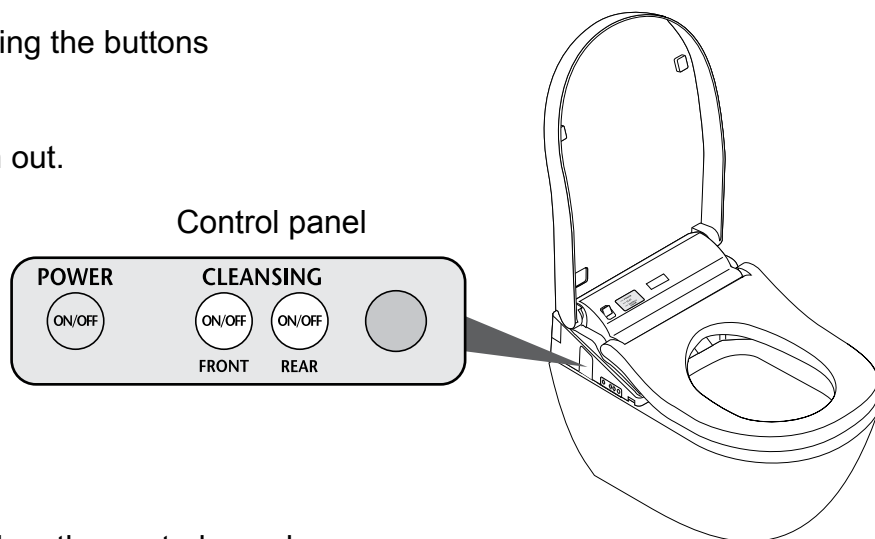

Replacing the batteries

- 1** Press [POWER ON/OFF] on the control panel.
 - The POWER LED goes off.

- 2** Remove the remote control from the hanger. (Page 14)

- 3** Open the cover and replace the AA batteries. (Page 14)

- 4** Mount the remote control in the hanger.

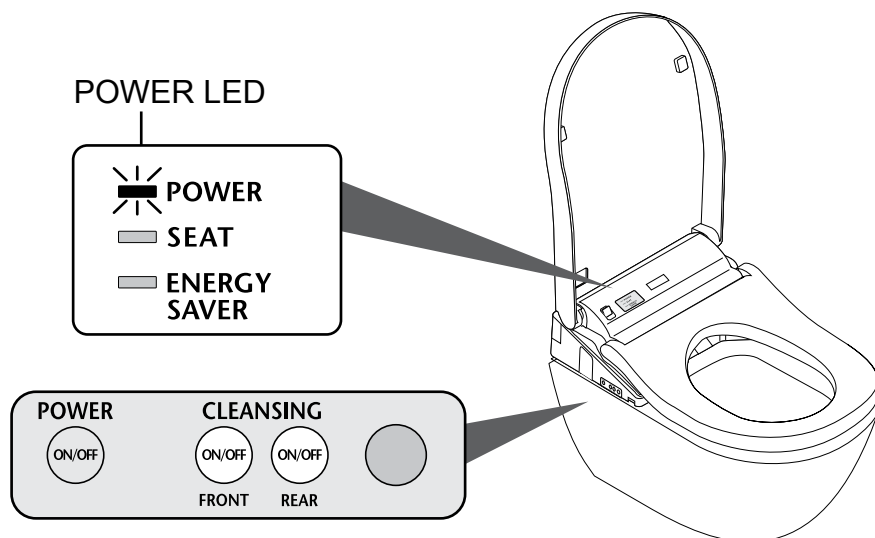

- 5** Press [POWER ON/OFF] on the control panel.
 - The POWER LED lights up.

What to Do? (Freeze Damage Prevention)

When the ambient temperature is likely to drop to 0°C or lower, take measures to prevent freezing.

Attention!

- When the ambient temperature is likely to drop to 0°C or lower, do not use the energy saver feature. (May damage the product.)
- Warm the bathroom or take measures against freeze so that the ambient temperature does not drop below 0°C.
- Before starting work, set „AUTO OPEN/CLOSE“ (Page 36) to „OFF“.

Anti freezing

How to drain the water

1 Close the shutoff valve.

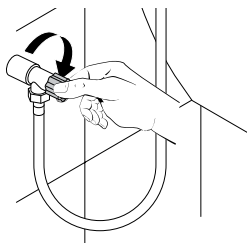

2 Drain the pipe.
1. Extend the nozzle.

- Operate with the buttons on the back side of the remote control.

(1) Press [MENU].

(2) Use  to select „CLEANING“.

Press [ENTER].

(3) Use  to select „NOZZLE CLEANING MODE ON/OFF“.

Press [ENTER] to extend the nozzle.

Press [ENTER] again to retract the nozzle.
(Release the pressure from the water supply pipe.)

2. Unplug the power plug. (Page 15)
Switch the breaker on the distribution board to OFF. (UK)

3. Remove the cover and water filter drain valve.

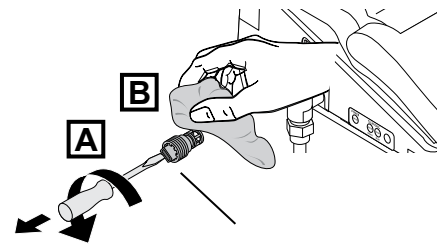
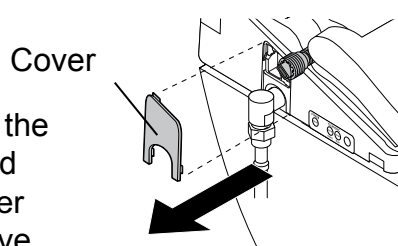

4. After draining the water, install the water filter drain valve and cover.
• Insert the water filter drain valve and use a flat-head screwdriver to tighten it securely.

Water filter drain valve

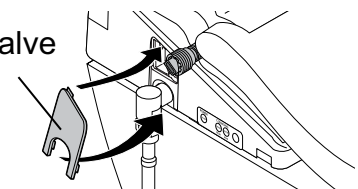

5. Insert the power plug. (Page 15)
Switch the breaker on the distribution board to ON. (UK)

3 Check that the POWER LED on the main display is lit up. (Page 15)

4 Set the toilet seat temperature to „High“. (Page 24)
(To maintain the temperature.)
• When finished, close the toilet seat and toilet lid.

5 To use VICLEAN[®] again
• The water needs to be resupplied. (Page 48)

What to Do? (Long Periods of Disuse)

If the toilet is in a location you will not visit for a long time, drain the water.
(The water in the tank may become contaminated and cause skin irritation or other problems.)

How to drain the water

1 Close the shutoff valve.
(Step **1** on Page 47)

2 Drain the pipe.
(Step **2** (1) to (4) on Page 49)

3 Pull out the water drain lever.

- The water comes out from near the nozzle for about 20 seconds.

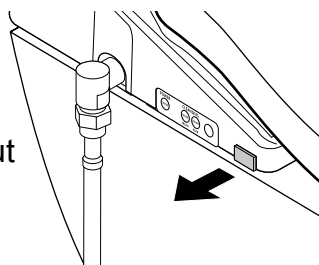

4 Release your hand to return the water drain lever to its original position.

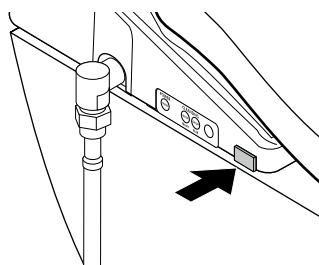

5 Take appropriate measures for the water remaining in the toilet bowl.
Putting antifreeze in the water remaining in the toilet bowl will reduce its chance of freezing.

- To use VICLEAN[®] again
The water needs to be resupplied.
(See right)

Resupplying the Water (After draining)

1 Open the shutoff valve.
Check that water is not leaking from a pipe or the main unit.

2 If the power is not turned ON
Insert the power plug.(Page 15)
Switch the breaker on the distribution board to ON. (UK)

3 Discharge water from the nozzle.
(1) Pressing down the left side of the toilet seat,
(2) Press the „REARWASH“ on the remote control to discharge water from the nozzle.
(Catch the water in a paper cup or other receptacle)

If the remaining water has frozen and no water comes out

- Heat the inside of the bathroom, and warm the water supply hose and shutoff valve using a cloth soaked in warm water.

Troubleshooting

First, try the actions described on pages 49 to 54. If the problem persists, consult the installer, seller or the contact listed on the back cover of this manual.

- The CLEAN indicator does not light up
(It is time for parts replacement → Page 54)



CAUTION

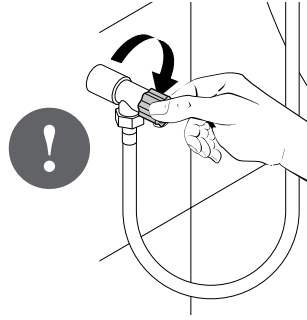

If a water leak occurs, close the shutoff valve

Please check first

Is the POWER LED lit?

- Does the LED light up when you press [POWER ON/OFF] on the main unit?
- Is the breaker on the distribution board turned on?
Check whether there is a power outage or the breaker has turned „OFF“.

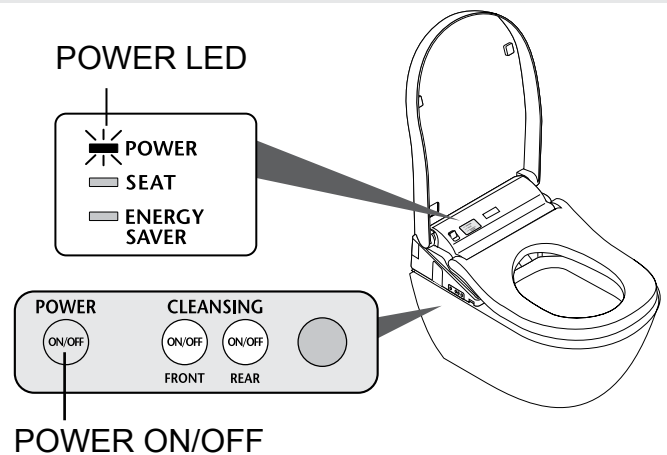

Is the ENERGY SAVER LED lit?

- While the LED is lit, energy saver (page 24) is in operation, so the toilet seat temperature may be reduced or the heater may be turned off.

Is the remote control working?

- Are the remote control batteries dead?
→ Replace the batteries
- Is the remote control transmitter or the remote control receiver blocked?
→ Remove obstructions, dirt, water droplets or any other blockages.

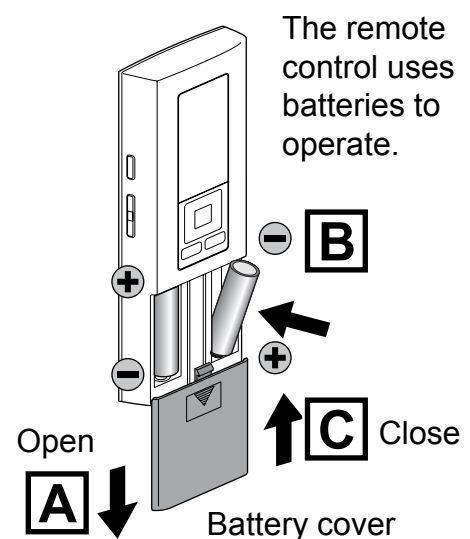
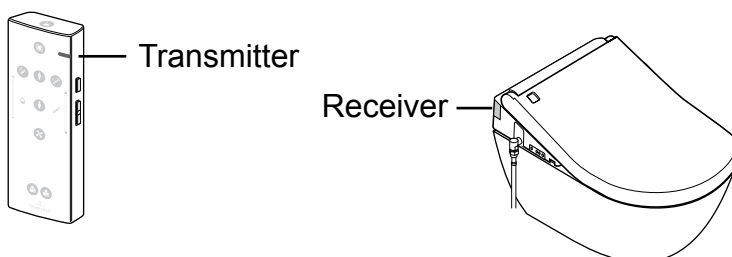

Troubleshooting

Rearwash and ladywash, nozzle

Trouble	Please check	Ref. Page
The nozzle (or cleanse water) does not come out	<ul style="list-style-type: none"> Can you operate with the control panel? (Check while sitting on the toilet seat.) → Check „Is the remote control working?“ 	12 49
	<ul style="list-style-type: none"> When the temperature is low, it takes time for the nozzle to come out after the remote control button is pressed because the water must be warmed up first. 	–
	<ul style="list-style-type: none"> Did you sit on the toilet continuously for 2 hours or longer? (If so, operation is stopped for safety purposes.) → Stand up from the seat and then use again. 	–
	<ul style="list-style-type: none"> If the water supply pressure drops significantly, for example if water is used elsewhere or if there is a water failure, the function may stop for safety. → Disconnect the power plug and wait about 10 seconds before inserting it again. → Switch the breaker on the distribution board to OFF and wait about 10 seconds before inserting it again. (UK) If the same symptom reappears → There may be a malfunction. Consult with the contact listed on the back cover of this manual. 	–
	<ul style="list-style-type: none"> The seat switch may have difficulty detecting some sitting postures. → Sit back on the toilet seat. 	11
	<ul style="list-style-type: none"> Are you using a toilet seat cover, a toilet lid cover or a seat for infants? → Remove any covers. When using a seat for infants or a soft highchair, remove after each use. 	11
The nozzle extends but the cleanse water does not come out /The cleanse water pressure is weak	<ul style="list-style-type: none"> Has a water failure occurred? → Press the „STOP“ button and wait until water service is restored. 	–
	<ul style="list-style-type: none"> Is the shutoff valve closed? 	15
	<ul style="list-style-type: none"> Is the water filter drain valve clogged with foreign matter? → Clean the filter. 	33
	<ul style="list-style-type: none"> Is the water pressure set to a low level? 	16
The cleanse water is cold	<ul style="list-style-type: none"> Is the water temperature set to „OFF“ or a low level? When the temperature of the water supply or the bathroom is low, the water temperature may be low when first sprayed. 	22 –
	<ul style="list-style-type: none"> Rearwash, rear soft and Ladywash stop automatically after 5 minutes of continuous use. After that, the POWER LED (green) and the ENERGY SAVER LED (green) on the display of the main unit flicker for about 60 sec. in order to prepare hot water. → Wait until the LEDs on the display of the main unit light up solidly and then press the button again. 	–
Stops in the middle of use	<ul style="list-style-type: none"> Does the seat switch have difficulty detecting? → Sit back on the toilet seat. If you get up slightly from the seat, or sit forward on the seat, the seating switch may temporarily stop detecting your presence 	11
	<ul style="list-style-type: none"> Water comes out from the area around the nozzle for several seconds after you sit on the toilet seat. 	20

Warm air drying

Trouble	Please check	Ref. Page
The dryer temperature is low	<ul style="list-style-type: none"> Is the remote control preset temperature set to a low level? 	22
Stops in the middle of use	<ul style="list-style-type: none"> The feature stops automatically after 10 minutes of continuous use. Does the seat switch have difficulty detecting? <ul style="list-style-type: none"> → Sit back on the toilet seat. If you get up slightly from the seat, or sit forward on the seat, the seating switch may temporarily stop detecting your presence. 	11

Toilet Seat and Toilet Lid

Trouble	Please check	Ref. Page
The toilet seat does not get warm	<ul style="list-style-type: none"> Is the toilet seat temperature set to „OFF“ or a low level? 	22
	<ul style="list-style-type: none"> Is the ENERGY SAVER LED (green) lit? <ul style="list-style-type: none"> Timer energy saver is operating and has turned off the toilet seat heater. <ul style="list-style-type: none"> → When you sit on the seat, the heater is turned on temporarily and the seat is warmed in about 15 minutes. Is the ENERGY SAVER LED (orange) lit? <ul style="list-style-type: none"> The toilet seat temperature has been lowered to save energy (The auto energy saver in operation). <ul style="list-style-type: none"> → When you sit on the seat, the heater is turned on temporarily and the seat is warmed in about 15 minutes. 	24
	<ul style="list-style-type: none"> Have you been seated for a long time? <ul style="list-style-type: none"> After about 20 minutes of sitting, the temperature starts going down, and after about 1 hour, the heater is turned „OFF“. <ul style="list-style-type: none"> → Move away from the toilet seat and then go back. 	-
	<ul style="list-style-type: none"> The seat switch may have difficulty detecting some sitting postures. <ul style="list-style-type: none"> → Sit back on the toilet seat. 	11
	<ul style="list-style-type: none"> Is a toilet lid or seat cover installed? <ul style="list-style-type: none"> → Remove any covers. 	11

Energy Saver

Trouble	Please check	Ref. Page
The timer energy-saver feature is not working	<ul style="list-style-type: none"> Did you replace the remote control batteries? <ul style="list-style-type: none"> When the batteries are discharged, the settings may be erased. <ul style="list-style-type: none"> → Reconfigure the setting. 	14 26
The auto energy-saver feature is not working	<ul style="list-style-type: none"> Because the function takes several days learning the usage conditions before starting energy saver, the amount of energy saving may be low, depending on the frequency of use. <ul style="list-style-type: none"> → Check the type of energy saver 	24

Troubleshooting

Toilet Seat and Toilet Lid (AUTO OPEN/CLOSE)

Trouble	Please check	Ref. Page
The toilet lid does not open automatically	<ul style="list-style-type: none"> • Is „AUTO OPEN/CLOSE (LID) „ set to „OFF“? → Set to „ON“. • Does the body sensor have difficulty detecting? → Remove any dirt that is on the body sensor. • Even when set to „ON“, AUTO OPEN/CLOSE (LID) is not performed for about 15 seconds after the toilet seat or toilet lid is closed. → When the toilet lid is closed by hand (To make the VICLEAN[®] user-friendlier, a time interval is set from when the lid is closed to when it will open next.) → Leave the bathroom, and then after 15 seconds or more, approach the toilet bowl. • Detection by the body sensor may be difficult when the room temperature exceeds 30°C. → Open and close manually. 	36 11 20 –
	<ul style="list-style-type: none"> • Is „AUTO OPEN WAITING TIME“ set to 30s or 90s? 	38
	<ul style="list-style-type: none"> • After the power plug is inserted, the toilet lid does not open automatically for about 10 to 60 seconds. → Open and close by hand. • After switching the breaker on the distribution board to ON, the toilet lid does not open automatically for about 10 to 60 seconds. → Open and close by hand. (UK) 	–
	<ul style="list-style-type: none"> • Is a toilet seat or lid cover installed? → Remove any covers. 	11
The toilet lid does not close automatically	<ul style="list-style-type: none"> • Is „AUTO OPEN/CLOSE (LID)“ set to „OFF“? → Set to „ON“. • When you do not sit on the toilet seat, or when the time spent sitting on the toilet seat or standing in front of it is 6 seconds or less, the toilet seat and toilet lid close after about 5 minutes. • If they do not close automatically even though „AUTO OPEN/CLOSE (LID) „ is set to „ON“, the body sensor may be detecting incorrectly. → If there is a reflective object in front, such as a mirror or glass, move the reflective object or use a curtain or other object to block it. 	36 20 11
	<ul style="list-style-type: none"> • Is the sensor directly exposed to sunlight? → Do not directly expose the sensor to sunlight, because it may cause incorrect detection. • Is there a heater within the detection range of the body sensor? → Do not place within the detection range of the sensor. • Is a urinal or wash basin also installed in the bathroom? → The sensor may detect someone using the urinal, causing the toilet lid to open or close. 	11
	<ul style="list-style-type: none"> • Is „AUTO OPEN/CLOSE (LID)“ set to „ON“? • Is AUTO CLOSE WAITING TIME set to 25s? • The seat switch may have difficulty detecting some sitting postures. → Sit back on the toilet seat. 	36 11
The toilet lid and toilet seat open at the same time	<ul style="list-style-type: none"> • Are the settings configured to open the toilet lid and toilet seat at the same time? 	38

Toilet Seat and Toilet Lid (AUTO OPEN/CLOSE)

Trouble	Please check	Ref. Page
Stops (or closes) while opening	<ul style="list-style-type: none"> If the lid or seat hits an obstruction the first time it opens after inserting the power plug, it may stop (or close) partway during the next operation. <ul style="list-style-type: none"> → While there are no obstructions, disconnect the plug and insert it again after about 5 seconds. Then press the „OPEN/CLOSE (Seat)“ button on the remote control. If the lid or seat hits an obstruction the first time it opens after switching ON the breaker on the distribution board, it may stop (or close) partway during the next operation. (UK) <ul style="list-style-type: none"> → Eliminate any obstructions and switch the breaker on the distribution board to OFF. Switch it to ON again after about 5 seconds. Then press the „OPEN/CLOSE (Seat)“ button on the remote control. (UK) 	–
Cannot open or close with the remote control	<ul style="list-style-type: none"> If it opens automatically <ul style="list-style-type: none"> → Check „Is the remote control working?“ 	49
	<ul style="list-style-type: none"> If automatic opening does not work either <ul style="list-style-type: none"> The toilet lid may not be mounted correctly. <ul style="list-style-type: none"> → Mount them correctly. 	30
	<ul style="list-style-type: none"> Incorrect detection may occur when operating under fluorescent lights. 	–

Air purifier

Trouble	Please check	Ref. Page
The air purifier seems to be not working	<ul style="list-style-type: none"> Even after sitting down, you do not hear operation sounds. <ul style="list-style-type: none"> → Sit back on the toilet seat. 	11
	<ul style="list-style-type: none"> If you hear an operation sound when you sit on the toilet seat. <ul style="list-style-type: none"> → Clean the deodorizing filter. 	31
A strange odor is emitted	<ul style="list-style-type: none"> Are you using an air freshener or Air purifier that you purchased separately? <ul style="list-style-type: none"> Doing so may reduce the effectiveness of the VICLEAN[®] air purifier or cause strange odors. <ul style="list-style-type: none"> → Remove the air freshener or air purifier. 	–
The air purifier is not working	<ul style="list-style-type: none"> Is „AIR PURIFIER“ set to „OFF“? <ul style="list-style-type: none"> → Set to „ON“. 	40

Night light

Trouble	Please check	Ref. Page
The night light does not light up	<ul style="list-style-type: none"> Is the setting „OFF“? <ul style="list-style-type: none"> → Set to „ON“. 	42

Troubleshooting

Others

Trouble	Please check	Ref. Page
Water is leaking from the plumbing connections	<ul style="list-style-type: none"> If any nuts in a connection are loose, firmly tighten them with a tool such as a monkey wrench. → If the water leak does not stop, close the shutoff valve and seek repair. 	-
The display on the remote control goes out	<ul style="list-style-type: none"> The display goes out when no button on the remote control is pressed for 1 minute or more. 	-
The main unit is unstable	<ul style="list-style-type: none"> There is clearance between the toilet seat cushion and the toilet bowl for activating the seat switch. When you sit on the toilet seat, the toilet seat subsides slightly to activate the seat switch. 	11
The main unit makes a sound	<p><When moving away from the toilet bowl after use></p> <ul style="list-style-type: none"> You may hear the sound of the remaining water being drained. You may hear the fan ventilating the unit. 	20

Important User Guidance Information



If you want to dispose this product, do not mix it with general household waste. There is a separate collection system for used electronic products in accordance with legislation that requires proper treatment, recovery and recycling.

Private households in the member states of the EU, Switzerland and Norway may return their used electronic products free of charge to designated collection facilities or to a retailer (if you purchase a similar new one).

For countries not mentioned above, please contact your local authorities for the correct method of disposal.

By doing so you will ensure that your disposed product undergoes the necessary treatment, recovery and recycling, which prevent potential negative effects on the environment and human health.

Only discard discharged batteries. They should not be disposed of with household waste, but rather at appropriate collection sites or at the product retailer.

Specifications

Item

VICLEAN[®]

Rated power supply		AC 220 - 240V, 50Hz		
Rated power consumption		(TENTATIVE) 845 - 855W		
Maximum power consumption		(TENTATIVE) 1528 W (When the water supply temperature is 0 °C)		
Type		Instantaneous		
Power cord length		0.7m, (0.76m in UK)		
Water protection level		IPX4		
Functions	Cleanse	Spray volume	Rearwash	Approx. 0.27L to 0.43L/min.
			Rear soft cleanse	Approx. 0.27L to 0.43L/min.
			Ladywash	Approx. 0.29L to 0.43L/min.
		Water temperature	Adjustable temperature range: OFF, about 30°C to 40°C	
		Heater capacity	1200 - 1428W	
		Safety device	Temperature fuse	
		Backflow prevention device	Vacuum breaker, Check valve, Air gap	
	Warm air dryer	Warm air temperature *	Adjustable temperature range : About 35°C to 55°C	
		Airflow volume	Approx. 0.29m ³ /min.	
		Heater capacity	200 - 238W	
		Safety device	Temperature fuse	
	Heated seat	Surface temperature	Adjustable temperature range: OFF, about 28°C to 36°C (About 26°C when auto energy saver is in operation)	
		Heater capacity	55 - 65W	
		Safety device	Temperature fuse	
	Air purifier	Method	O ₂ deodorizing	
		Airflow volume	Approx. 0.16 m ³ /min.	
		Power consumption	Approx. 5.3W	
Water supply pressure		Minimum required water pressure: 0.1MPa (dynamic), Maximum required water pressure: 1.0MPa (static)		
Water supply temperature		0°C to 35°C		
Working ambient temperature		0°C to 40°C		
Dimensions		W 392mm x D 547mm x H 134mm		
Net Weight		(TENTATIVE) About 5.6kg		

* Temperature around the warm air outlet measured by Villeroy & Boch.

Reference

VILLEROY & BOCH

DEUTSCHLAND

*Villeroy & Boch AG
Unternehmensbereich Bad und Wellness
Hauptverwaltung
66693 Mettlach*

EN

09-2013

Farbtöne und Abmessungen unterliegen den üblichen Toleranzen. Technische Änderungen und Farbtonanpassungen vorbehalten.