





# Index



















<b>Cutlery</b> .....	04
Zeta.....	06
Impulso.....	06
Stiletto.....	07
Luce.....	07
City.....	08
Sky.....	08
Sedona.....	09
Metropolitan.....	09
Medici.....	10
Rialto.....	10
Dakar wengè.....	11
Dakar acacia.....	11
Splendido.....	12
Enrico VIII.....	12
Boty.....	13
Matisse.....	13
Più.....	14
Style.....	14
Scozia.....	15
Mare.....	15
Special finish Moon dust.....	16
Special finish Vintage.....	17
Special finish PVD.....	18
<b>Additional Items &amp; Holloware</b> .....	19
Additional Items.....	20
Holloware.....	23
<b>Buffet</b> .....	29
Italo.....	30
Manhattan.....	32
Urban.....	33
Chefing Dish.....	34
Zeta.....	36
Square.....	40
Square Revolution.....	41
Mix&Play Revolution.....	42





# Cutlery

Specific assortments vary by pattern

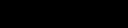
0040		Table spoon
0050		Table fork
0130		Sopue spoon
0065		Table knife
0070		Dessert spoon
0080		Dessert fork
0093		Dessert knife
0160		Tea spoon
0180		Moka spoon
1800		Soup ladle
1740		Serving fork
1730		Serving spoon
0100		Fish fork
0110		Fish knife
0600		Ice tea spoon
0190		Cake fork
1870		Cake server
0563		Butter knife
0545		Steak knife
1760		Sauce spoon

## Zeta

stainless steel 18/10  
cod. 16-9452



## Impulso

stainless steel 18/10  
cod. 16-9457



**Stiletto**

stainless steel 18/10  
cod. 16-9451



**Luce**

stainless steel 18/10  
cod. 16-9456

# Cutlery Broggi

## City

stainless steel 18/10  
cod. 16-9454



## Sky

stainless steel 18/10  
cod. 16-9458



**Sedona**  
stainless steel 18/10  
cod. 16-9464

**Metropolitan**

stainless steel 18/10  
cod. 16-9453



## Medici

stainless steel 18/10  
cod. 16-9450



## Rialto

stainless steel 18/10  
cod. 16-9455



**Dakar**

stainless steel 18/10  
cod. 16-9472 wengé

**Dakar**

stainless steel 18/10  
cod. 16-9473 acacia



## Splendido

stainless steel 18/10 - 3,5 mm  
cod. \*C19..



## Enrico VIII

stainless steel 18/10 - 2,5 mm  
cod. \*CUB..



## Boty

stainless steel 18/10 - 3 mm  
cod. \*CD2..

## Matisse

stainless steel 18/10 - 2,5 mm  
cod. 16-9490



# Cutlery Abert

## Più

stainless steel 18/10 - 3 mm  
cod. 16-9491



## Style

stainless steel 18/10 - 3 mm  
cod. 16-9492



**Scozia**

stainless steel 18/10 - 3 mm  
cod. 16-9493

**Mare**

stainless steel 18/10 - 3 mm  
cod. 16-9494



# Special Finish

**The Polvere di Luna finish makes** cutlery surface look satin-like and delicately brilliant: a smooth surface with contrasting shades. Pleasant and velvety to the touch, the cutlery so treated convey a softness and warmth unusual for steel objects. A sober and unusual coating for contemporary cutlery.

## Polvere di Luna

cod. \*...32

*Finish available for all models  
Not available for hollow-handle cutlery  
500 assorted pcs minimum order*



**Moon dust PVD Gold**  
cod. \*...35

**Moon dust PVD Copper**  
cod. \*...53

**Moon dust PVD Black**  
cod. \*...39



## Opacity, scratches and marks

intentionally made on the surface of the cutlery with a Vintage finish give the effect of objects that have been used for a long time, of a large, warm and steamy kitchen filled with aromas, of the friendly gatherings of old good times and ancient flavours. They evoke images of traditional, simple environments with no intention to be modern.

## Vintage

cod. \*...51

*Finish available for all models  
Not available for hollow-handle cutlery  
500 assorted pcs minimum order*

## Vintage PVD Gold

cod. \*...57

## Vintage PVD Copper

cod. \*...56

## Vintage PVD Black

cod. \*...58



# Special Finish

**The PVD (Physical Vapour Deposition)** technique allows to deposit a high-thickness metal film with remarkable characteristics from the decorative and technical point of view. Such process makes the product treated durable in time and gives high surface hardness. The item turns resistant to solvents, acids and to various products used in the kitchen, keeping its chemical/physical characteristics unchanged. It is a thoroughly biocompatible, anallergic treatment and suitable for food contact.

## PVD

cod. \*...40

cod. \*...41

cod. \*...42

*Finish available for all models*

*Not available for hollow-handle cutlery*

*500 assorted pcs minimum order*



### PVD Gold

cod. \*...41

### PVD Copper

cod. \*...40

### PVD Black

cod. \*...42



# Additional Items & Hollowware



# Additional Items

## Marchesi Steak Set

	In.
*117 05 01 059	9,1/2
<i>Smooth blade knife</i>	
*117 05 01 002	8,1/4
<i>Fork</i>	



## Steak knife

	In.
*305 05 91 797	9,1/4
<i>Black handle</i>	
*305 45 91 797	9,1/4
<i>Ivory handle</i>	



## Steak knife, solid handle

	In.
16-9459-0545	8,1/4



## Fiorentina steak knife, stainless steel

	In.	
16-9497-0540	9	



## Angus steak knife, stainless steel

	In.
16-9464-0540	9



## Modern steak knife, stainless steel

	In.
16-9495-0540	9



## Chopstick Stand

	In.
16-9459-2155	3 x 1,1/8



**Palio snail fork**

\*165 05 00 063 In.  
6,1/8



**Palio oyster fork**

\*165 05 00 064 In.  
5,1/2



**Oyster pick**

\*CPA 64 In.  
8,7/8



**Lobster pick**

\*903 05 84 659 In.  
7,1/4



**Lobster cracker**

\*305 05 91 658 In.  
8



**Professional serving spoon**

16-9459-1772 In.  
11,1/2



**Professional serving fork**

16-9459-1774 In.  
11,5/8



**Professional rice-serving spoon**

16-9459-1470 In.  
10



*\*Special Import Item: Please allow 4-6 weeks for delivery*

# Additional Items

## Multipurpose tongs

16-9459-1993 In.  
11,5/8



## Pasta tongs

16-9459-1992 In.  
10,5/8



## Salad tongs

16-9459-1991 In.  
10,5/8



## Universal tongs

16-9459-1994 In.  
10,5/8



## Roast tongs

16-9459-1256 In.  
8,7/8



## Cake tongs

16-9459-1972 In.  
8,7/8



## Ice tongs

16-9459-4495 In.  
7,7/8



## Spaghetti tongs

16-9459-1990 In.  
8,7/8



## Zeta creamer/milk pot

	Oz.	In.
16-9462-6202	5	3,7/8 x 3,1/2



## Zeta coffee pot

	Oz.	In.
16-9462-6200	50	7,7/8 x 3,7/8 x 8,5/8



## Zeta teapot

	Oz.	In.
16-9462-6201	13	6 x 3 x 4,3/4
16-9462-6236	17	4,1/2 x 6,1/4 x 4,1/4



## Zeta water pincher

	Oz.	H. In.
16-9462-6205	50	7,5/8



## Zeta sugar/tea bag holder

	In.	H. In.
16-9462-6204	4,3/4 x 2,1/2	1,1/2



## Zeta sugar bowl

	H. In.
16-9462-6203	2,3/8



## Zeta salt and pepper shakers

	H. In.
16-9462-6206	2
Salt	
16-9462-6207	2
Pepper	



# Holloware

## Gourmet boat

16-9462-6214 In.  
13 x 4

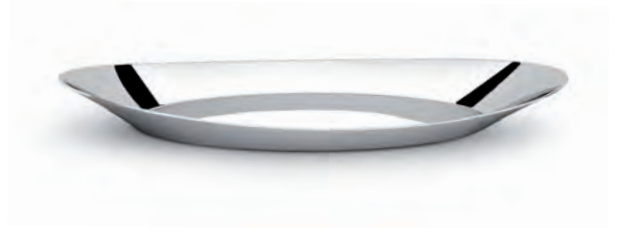

## Bread basket

16-9462-6213 In.  
11,3/4 x 6,1/4



## Bread basket Square

\*V76 05 24 002 In.  
7,7/8 x 4,3/4



## Bread basket Square

\*V76 05 24 003 In.  
10,5/8 x 4,3/4



## Bread basket

\*305 29 24 581 In.  
5 x 5  
\*305 29 24 582 7,5/8 x 7,5/8  
*Brown*  
\*305 29 24 583 5 x 5  
\*305 29 24 584 7,5/8 x 7,5/8  
*Ecru*



## Thermal cushion

\*325 05 24 579 In.  
5,1/8 x 5,1/8  
\*325 05 24 580 7 x 7



## Bread basket, oval

\*V01 05 24 028 In.  
11 x 6



## Multipurpose bowl

	In.	H. In.
16-9462-6218	5,1/8 x 4	2



## Double-spout sauce boat

	In.	H. In.
*305 05 12 624	6,1/4 x 4	2,1/8



## Round bar tray

	Ø In.
16-9463-6300	12,5/8
16-9463-6301	15
16-9463-6302	18,1/8



## Koku show plate

	In.
16-9461-6104	12,1/4 x 12,1/4

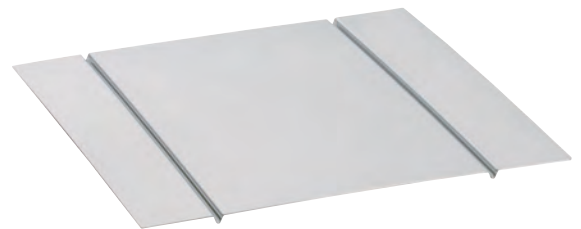

## Veneto coffee pot

	Oz.
16-9460-6000	31,5
16-9460-6001	53
16-9460-6002	70



## Veneto creamer/milk jug

	Oz.
16-9460-6003	53
16-9460-6004	70



## Veneto sugar bowl with cover and handles

	Gr.	Oz.
16-9460-6005	250	8,75



# Holloware

## Zeta Champagne bucket

	In.	H. In.
16-9462-6209	7,1/2 x 6	7,5/8



## Zeta Champagne bucket stand

	H. In.
16-9463-6309	26



## Zeta Glacette

	In.	H. In.
16-9462-6212	5,3/4 x 4,1/8	8,5/8

## Zeta Ice bucket

	In.	H. In.
16-9462-6210	6,1/4 x 5	6,1/2



## Modern Champagne cooler

	Ø In.	H. In.
*V78 05 20 002	9,1/2	8,7/8

## Imperial Champagne cooler

	Ø In.	H. In.
*V01 05 20 020	8,1/4	7,7/8



## Imperial champagne cooler stand

	Ø In.	H. In.
*V01 05 20 675	8,1/4	24



## Champagne cooler for 2/3 bottles

	Ø In.	H. In.
*V78 05 20 022	8,5/8	8,1/4



## Wine & Bar champagne cooler stand

	Ø In.	H. In.
*V78 05 20 675	9	22,7/8



## Double wall bottle cooler

	Ø In.	H. In.
16-9463-6303	5,1/8	8,1/4

## Double wall ice bucket

	Ø In.	H. In.
16-9463-6308	5,1/8	7,1/8



## Cocktail shaker

	Oz.
16-9463-6305	17,5



## 1 Cocktail strainer

	In.
16-9463-9304	5,3/4

## 2 Pub measure

	Oz.
16-9463-6307	1-1/2

## 3 Champagne bottle stopper

	In.
16-9463-6306	2,1/8



# Holloware

## Iseo insulated beverage server

16-9461-6100 Oz.  
35



## Show plate

16-9461-6101 Ø In..  
11, 3/4



## Change tray

16-9462-6211 In.  
8,1/4 x 5,3/8



## Bottle coaster

\*V01 05 21 014 In.  
5,1/2



## Glass coaster

\*V01 05 21 011 In.  
4,3/8



## Imperial oil & vinegar cruet set, 2-piecer

\*V01 05 12 002 In.  
8,7/8



## Imperial salt/pepper shaker

\*V01 05 12 001 In.  
3,3/8



Buffet

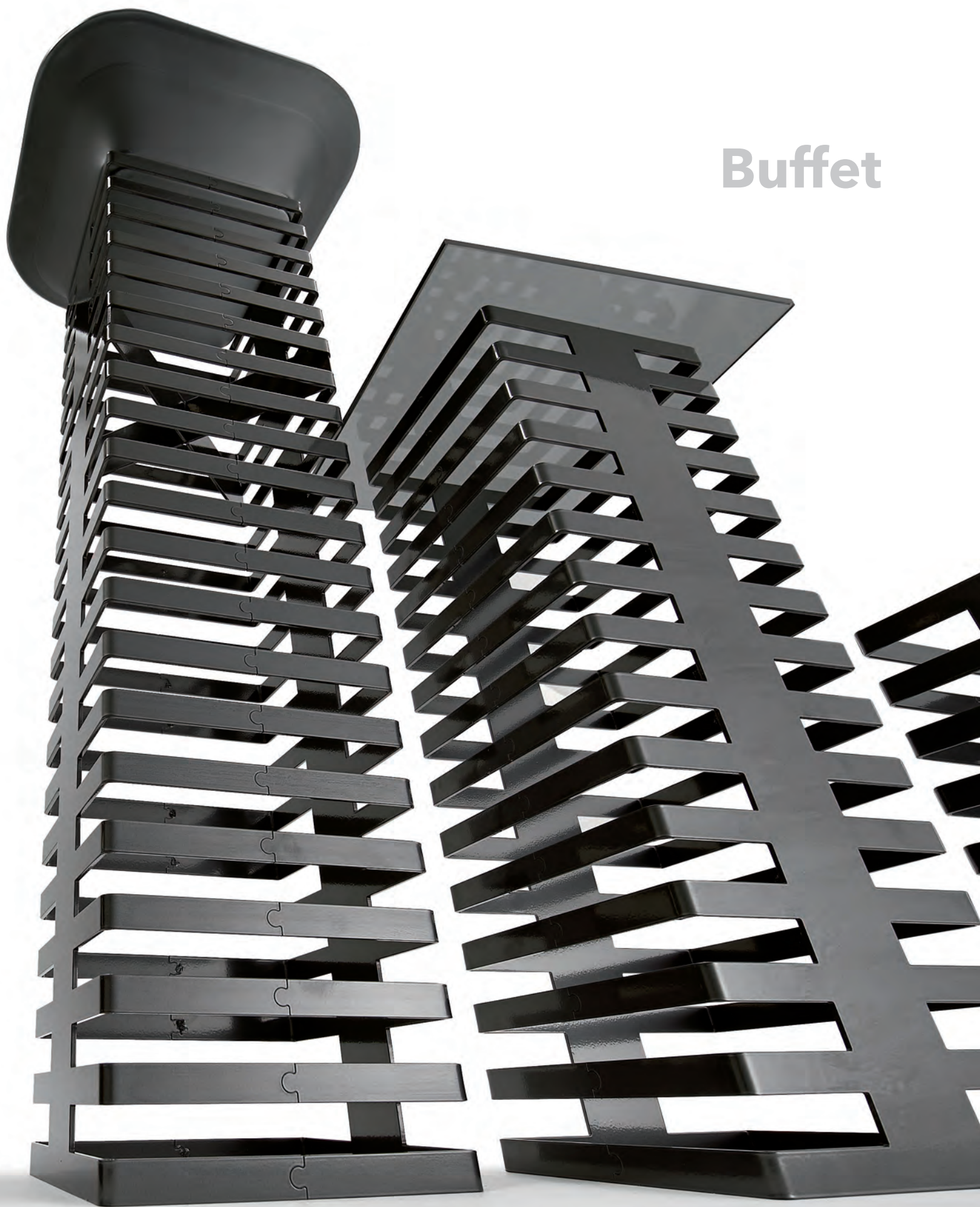

## Rosewood

\*305 51 52 647

*Trolley*

\*305 51 52 648

*Table 3*

Closed In.

45,9/32 x 23,15/64 H.3,53/64

52,23/64 x 25,19/32 H.41,11/32

Open In.

155,29/32 x 25,19/32 H.3,53/64



**Dark oak**

\*305 04 52 647  
Trolley  
\*305 04 52 648  
Table 3

Closed In.  
45,9/32 x 23,15/64 H.3,53/64  
52,23/64 x 25,19/32 H.41,11/32

Open In.  
155,29/32 x 25,19/32 H.3,53/64



\*Special Import Item: Please allow 6-8 weeks for delivery

# Manhattan



## Manhattan Set 3

	In.	H. In.
*305 05 52 A03	59,1/16 x 57,3/32	26,3/8

## Manhattan Set 1

	In.	H. In.
*305 05 52 A01	55,1/8 x 16,1/2	26,3/8



## Manhattan Set 2

	In.	H. In.
*305 05 52 A02	55,1/8 x 16,1/2	17

## Manhattan Set 4

	In.	H. In.
*305 05 52 A04	102,1/3 x 16,1/2	26,3/8



**Urban Set 3**

\*V87 32 42 003      In.                      H. In.  
 59,1/16 x 57,3/32    26,3/8

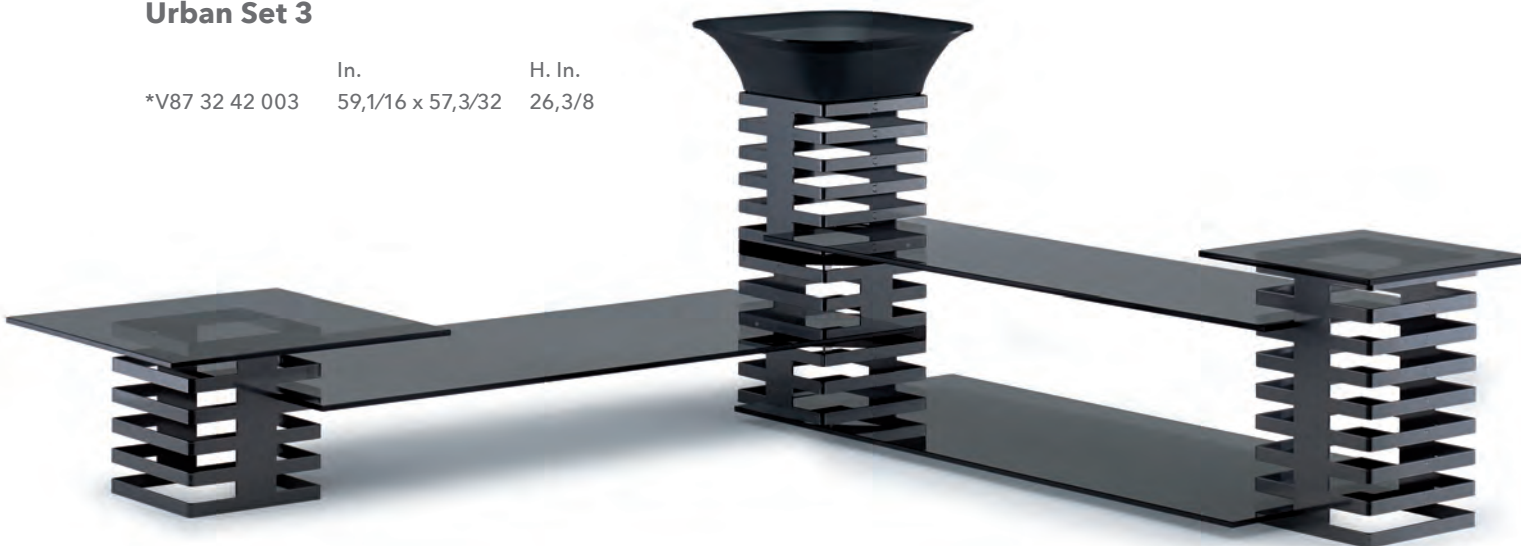

**Urban Set 1**

\*V87 32 42 001      In.                      H. In.  
 55,1/8 x 16,1/2      26,3/8

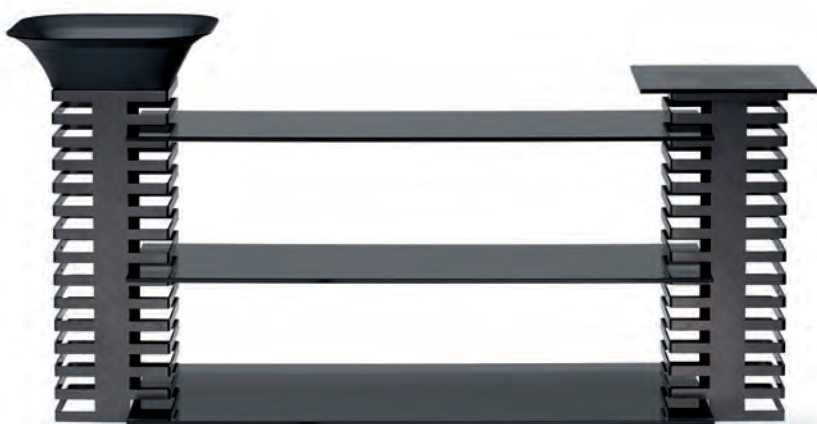

**Urban Set 2**

\*V87 32 42 002      In.                      H. In.  
 55,1/8 x 16,1/2      17



**Urban Set 4**

\*V87 32 42 004      In.                      H. In.  
 102,1/3 x 16,1/2    26,3/8

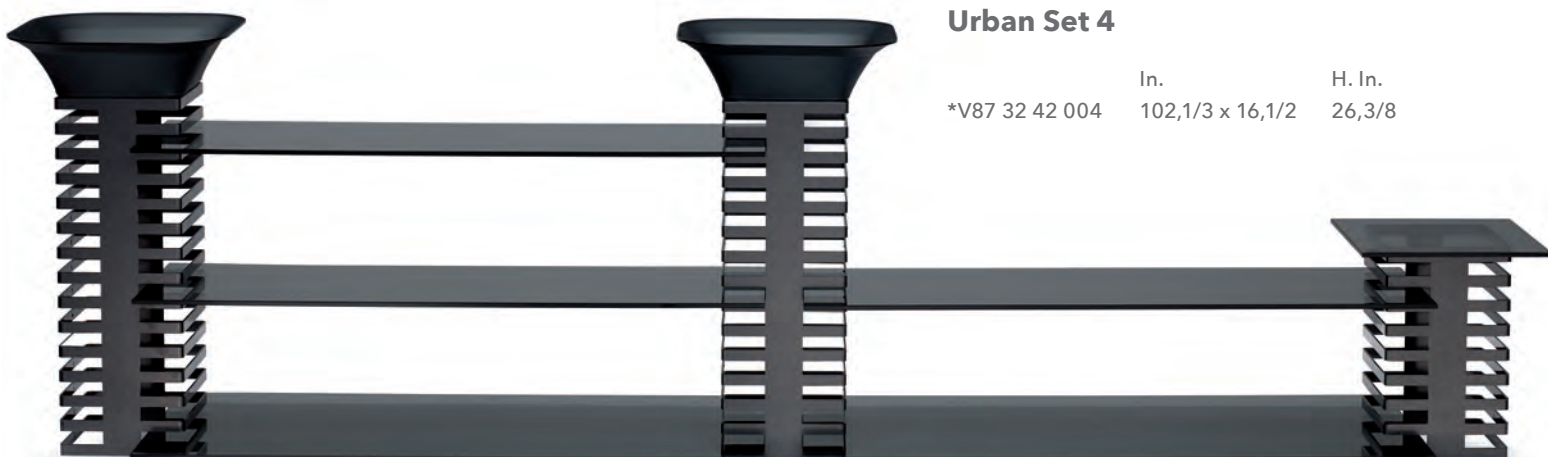

# Chafing Dish

## Classica rectangular chafing dish

	GN	In.	H. In.
*303 55 52 612	1/1	26,3/8 x 17	17,3/4

St. Steel

With revolving foldaway dome opening at 180°  
1/1 Gastronorm food pan and two solid fuel burners.  
Electric heating element available.



## Classica round chafing dish

	Ø In.	H. In.
*303 55 52 614	15,3/4	X

St. Steel

With revolving foldaway dome opening at 180°  
Gastronorm food pan and two solid fuel burners.  
Electric heating element available.



## Iseo rectangular chafing dish

	GN	In.	H. In.
*305 55 52 615	1/1	26,3/4 x 20	17,3/4

St. Steel

With revolving foldaway dome opening at 180°  
1/1 Gastronorm food pan and two solid fuel burners.  
Electric heating element available.



## Iseo round chafing dish

	Ø In.	H. In.
*303 55 52 617	15,3/4	18,1/8

St. Steel

With revolving foldaway dome opening at 180°  
Gastronorm food pan and two solid fuel burners.  
Electric heating element available.



## Manhattan chafing dish with St. Steel stand

	GN	In.	H. In.
*305 05 52 670 St. Steel Cover	1/1	25,3/4 x 16, 1/2	12,1/4
*305 05 52 679 Glass/St. Steel Cover	1/1	25,3/4 x 16, 1/2	12,1/4
*305 05 52 675 St. Steel Cover	2/3	18,1/8 x 16,1/2	12,5/8
*305 05 82 683 Glass/St. Steel Cover	2/3	18,1/8 x 16,1/2	12,5/8

With 1/1 Gastronorm food pan  
and two solid fuel burners.  
Electric heating element available.



## Manhattan built-in chafing dish

	GN	In.	H. In.
*305 05 52 693 St. Steel Cover	1/1	23,7/8 x 16	15,1/2
*305 05 52 692 Glass/St. Steel Cover	1/1	23,7/8 x 16	15,1/2
*305 05 52 695 St. Steel Cover	2/3	17 x 15,3/4	8,1/4
*305 05 52 694 Glass/St. Steel Cover	2/3	17 x 15,3/4	8,1/4



## Urban chafing dish with St. Steel stand

	GN	In.	H. In.
*V87 18 52 001 St. Steel Cover	1/1	25,3/4 x 16,1/2	12,1/4
*V87 18 52 005 Glass/St. Steel Cover	1/1	25,3/4 x 16, 1/2	12,1/4
*V87 18 52 004 St. Steel Cover	2/3	18,1/8 x 16,1/2	12,5/8
*V87 18 52 006 Glass/St. Steel Cover	2/3	18,1/8 x 16,1/2	12,5/8

With two solid fuel burners,  
electric heating element available.  
With GN 1/1 Gastronorm food pan



## Thermal juice dispenser

	Oz.	In.	H. In.
16-9462-6220	237	9,7/8 x 13,3/4	20,7/8
16-9462-6228	118	7 x 11,3/4	19



## Coffee urn

	Oz.	In.	H. In.
*305 05 52 631	237	9,7/8 x 13,3/4	21,1/4
16-9462-6219	338	9,7/8 x 13,3/4	24,3/8

## Single cereal dispenser

	Kg.	In.	H. In.
16-9462-6223	1,5	6 x 9,1/2	22,7/8



## Double cereal dispenser

	Kg.	In.	H. In.
16-9462-6222	2 x 1,5	9,7/8 x 12,5/8	22,7/8

**Double thermal pitcher**

	Oz.	In.	H. In.
16-9462-6221	51	16,1/2 x 9,1/2	8,5/8



**Thermal fruit salad bowl**

	Oz.	In.	Ø In.
16-9462-6226	61	11,3/4 x 11,3/4 H. 6,1/4	9



**Thermal yogurt set, 2-bowl**

	Oz.	In.	Ø In.
16-9462-6225	17	16,1/2 x 9,1/2 H. 5,3/8	6



**Thermal fruit-salad set, 2-bowl**

	Oz.	In.	Ø In.
16-9462-6224	61	21,5/8 x 13,5/8 H. 6,1/4	9



**Thermal pitcher 4-pc set**

	In.	H. In.
*305 05 24 586	11,3/4 x 11,3/4	4



**Water glass pitcher with smart lid**

	Oz.	Ø In.	H. In.
*305 05 08 548	35	4,1/8	11,1/4



*\*Special Import Item: Please allow 4-6 weeks for delivery*

# Zeta

## Bread basket with roll-top cover

\*305 05 52 650      In.      H. In.  
21,5/8 x 13,5/8      9,7/8



## Thermal cheese/cold cuts tray

16-9462-6231      In.      H. In.  
21,5/8 x 13,5/8      7,7/8



## Bread basket with roll-top cover

16-9462-6227      In.      H. In.  
21,5/8 x 13,5/8      11,3/4



## Bread cutting board with base

16-9462-6232      In.      H. In.  
21,5/8 x 13,5/8      2,3/8

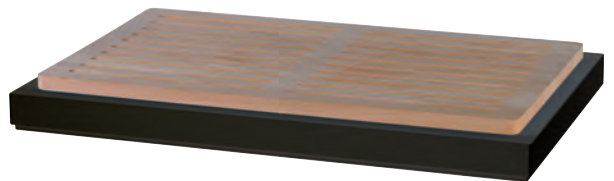

## Wire stand for GN 1/1

16-9462-6215      In.      H. In.  
21,5/8 x 13,5/8      10,7/8

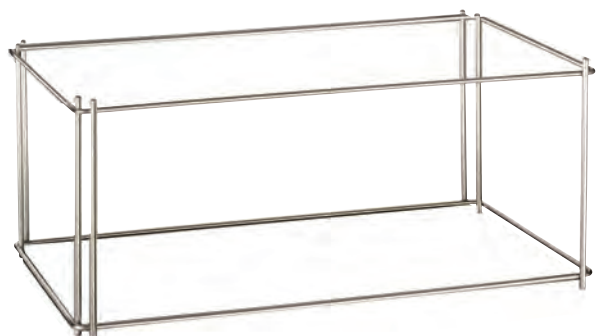

**Cake stand with roll-top cover**

16-9462-6216	Ø In.	In.	H. In.
<i>piatto/dish</i>	15		
<i>base/base</i>		7 x 7	14,1/2



**Punch bowl**

16-9462-6217	Oz.	In.	H. In.
	507	7 x 7	13



**Multipurpose tray**

16-9462-6230	In.	H. In.
	11,3/4 x 11,3/4	1,1/2



**Multipurpose tray**

16-9462-6235	In.	H. In.
	21,5/8 x 13,5/8	1,1/2



**3-bowl podium, tall**

16-9462-6234	Oz.	In.	H. In.	Ø In.
<i>Tall</i>	8,5	16,3/4 x 6	7,1/2	4,3/4
16-9462-6233	8,5	16,3/4 x 6	4,3/4	4,3/4
<i>Short</i>				



# Square

## Square juice dispenser

	Oz.	In.	H. In.
*V76 05 52 003	237	9,7/8 x 13,3/4	20,7/8
*V76 05 52 009	118	7 x 11,3/4	19



## Square coffee urn

	Oz.	In.	H. In.
*V76 05 52 001	350	9,1/2 x 12,1/4	24

## Square cereal dispenser

	Oz.	In.	H. In.
*V76 05 52 010	122,5	7 x 10,5/8	20,7/8
*V76 05 52 011	140	7 x 10,5/8	26,3/4



## Square thermal rectangular cheese dish

	In.	H. In.
*V76 05 54 R01	19,5/8x11,7/8	7,7/8





## Square Revolution juice dispenser

	Oz.	In.	H. In.
*V76 05 52 003 R	237	10,5/8 x 14,1/2	22
*V76 05 52 009 R	118	7,3/4 x 12,1/2	20,1/8



## Square Revolution coffee urn

	Oz.	In.	H. In.
*V76 05 52 001 R	350	10,1/4 x 13	25,1/8



## Square Revolution cereal dispenser

	Oz.	In.	H. In.
*V76 05 52 010 R	122,5	7,3/4 x 11,3/8	22
*V76 05 52 011 R	140	7,3/4 x 11,3/8	27,7/8

## Square Revolution thermal rectangular cheese dish

	In.	H. In.
*V76 05 54 R01 R	21,1/4 x 13,1/4	8,1/2



# Mix&Play Revolution

## Mix&Play Revolution set1

	In.	H. In.
*V86 32 42 003	20,5/8 x 27,1/2	9,1/2
<i>Black</i>		
*V86 32 42 010	20,5/8 x 27,1/2	9,1/2
<i>Silver</i>		



## Mix&Play Revolution set2

	In.	H. In.
*V86 32 42 004	13,3/4 x 27,1/2	9,1/2
<i>Black</i>		
*V86 32 42 011	13,3/4 x 27,1/2	9,1/2
<i>Silver</i>		



## Mix&Play Revolution set3

	In.	H. In.
*V86 32 42 005	20,5/8 x 27,1/2	8,7/8
<i>Black</i>		
*V86 32 42 012	20,5/8 x 27,1/2	8,7/8
<i>Silver</i>		



## Mix&Play Revolution set4

	In.	H. In.
*V86 32 42 006	20,5/8 x 27,1/2	8,7/8
<i>Black</i>		
*V86 32 42 013	20,5/8 x 27,1/2	8,7/8
<i>Silver</i>		



## Mix&Play Revolution set5

	In.	H. In.
*V86 32 42 007 <i>Black</i>	20,5/8 x 27,1/2	6,1/4
*V86 32 42 014 <i>Silver</i>	20,5/8 x 27,1/2	6,1/4



## Mix&Play Revolution set6

	In.	H. In.
*V86 32 42 008 <i>Black</i>	20,5/8 x 20,5/8	6,1/4
*V86 32 42 015 <i>Silver</i>	20,5/8 x 20,5/8	6,1/4



## Mix&Play Revolution set7

	In.	H. In.
*V86 32 42 009 <i>Black</i>	20,5/8 x 20,5/8	6,1/4
*V86 32 42 016 <i>Silver</i>	20,5/8 x 20,5/8	6,1/4



\*Special Import Item: Please allow 4-6 weeks for delivery



[www.broggi.com](http://www.broggi.com)



**Villeroy & Boch**  
1748

**Villeroy & Boch - Hotel & Restaurant**

3A South Middlesex Avenue - Monroe Township, NJ 08831  
800.VILLEROY

[info.hr@villeroy-boch-usa.com](mailto:info.hr@villeroy-boch-usa.com)  
[www.villeroy-boch.com/hotel](http://www.villeroy-boch.com/hotel)